

SECTIONAL ISOMETRIC VIEW
SHOWING CLEAT LOCATION



99 SOUTH STREET, PASSAIC, NJ 07055
(p) 973-916-1166 (e) estimating@rpgacoustic.com

Title: RPG DIFFRACTAL 4X2 WALL
MOUNTING WOOD CLEAT

Proj: RPG PRODUCT

Date: 8/22/22

By: CNN

Scale: NTS

Comments:

Path: F:\Project Mgmt - RPG\RPG PRODUCTS\ALL PRODUCTS DRAWING\DIFFRACTAL\1-AutoCAD Drawings\Mounting\Diffraction Mounting R3

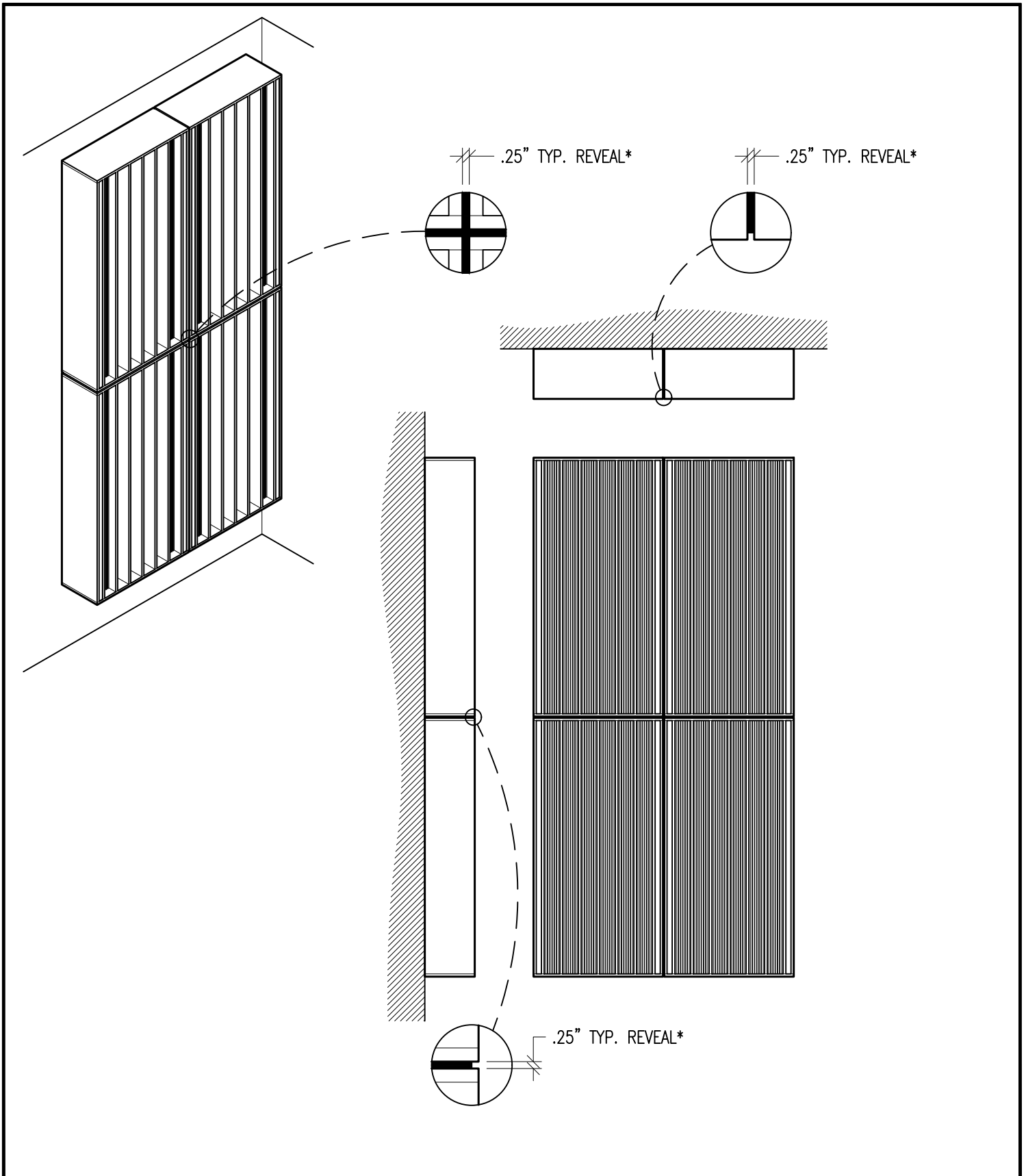

99 SOUTH STREET, PASSAIC, NJ 07055
 (p) 973-916-1166 (e) estimating@rpgacoustic.com

Title: RPG DIFFRACTAL 4X2 EE ARRAY
 WALL MOUNTING

Proj: RPG PRODUCT

Date: 8/22/22

By: CNN

Scale: NTS

Comments:

Path: F:\Project Mount - RPG\RPG PRODUCTS\ALL PRODUCTS DRAWING\DIFFRACTAL\1-AutoCAD Drawings\Mounting\Diffraction Mounting R3

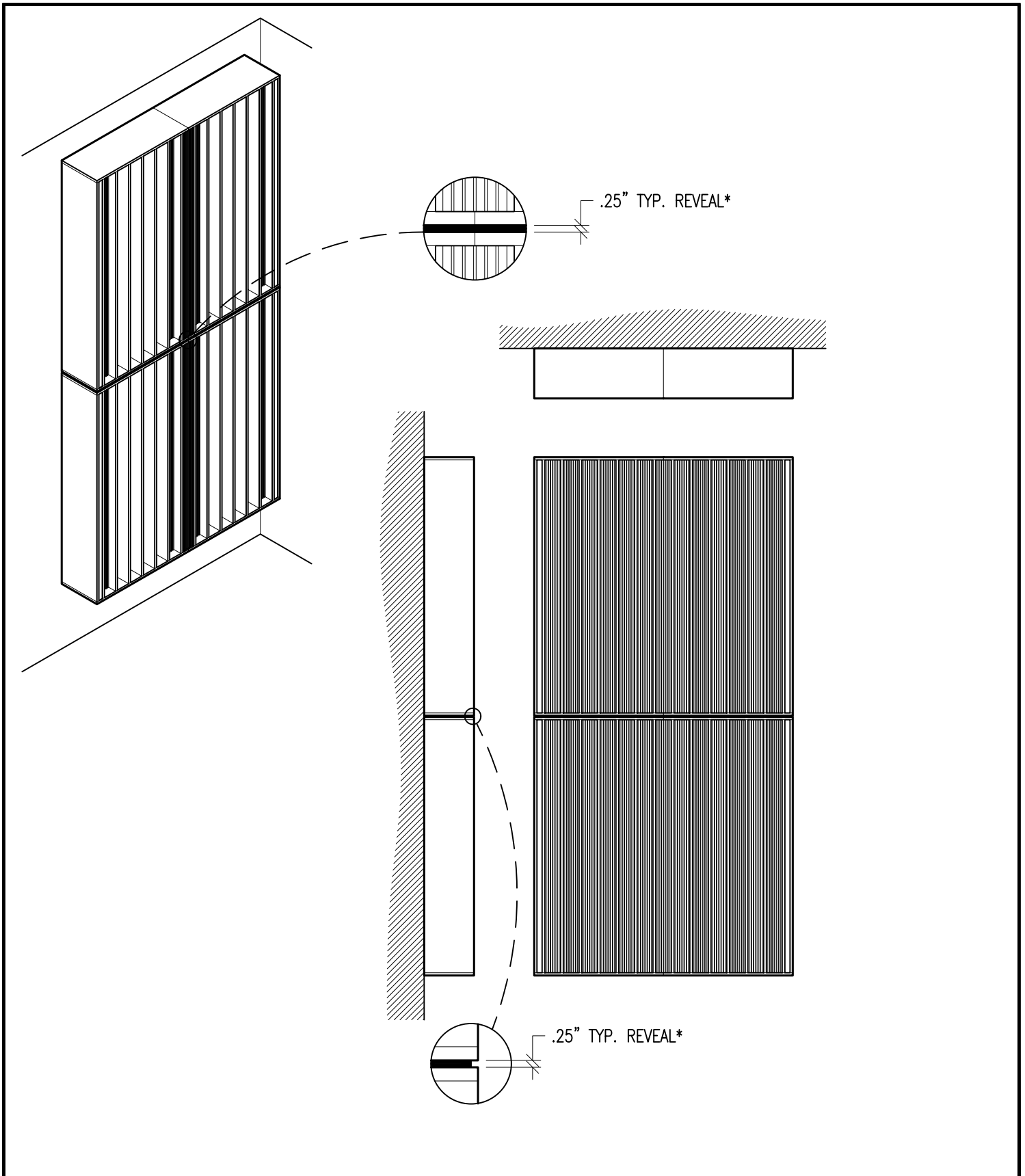

99 SOUTH STREET, PASSAIC, NJ 07055
 (p) 973-916-1166 (e) estimating@rpgacoustic.com

Title: RPG DIFFRACTAL 4X2 EJ ARRAY
 WALL MOUNTING

Proj: RPG PRODUCT

Date: 8/22/22

By: CNN

Scale: NTS

Path: F:\Project Mgmt - RPG\ -RPG PRODUCTS\ALL PRODUCTS DRAWING\DIFFR_Diffractal\1-AutoCAD Drawings\Mounting\Diffractal Mounting R3

Comments:

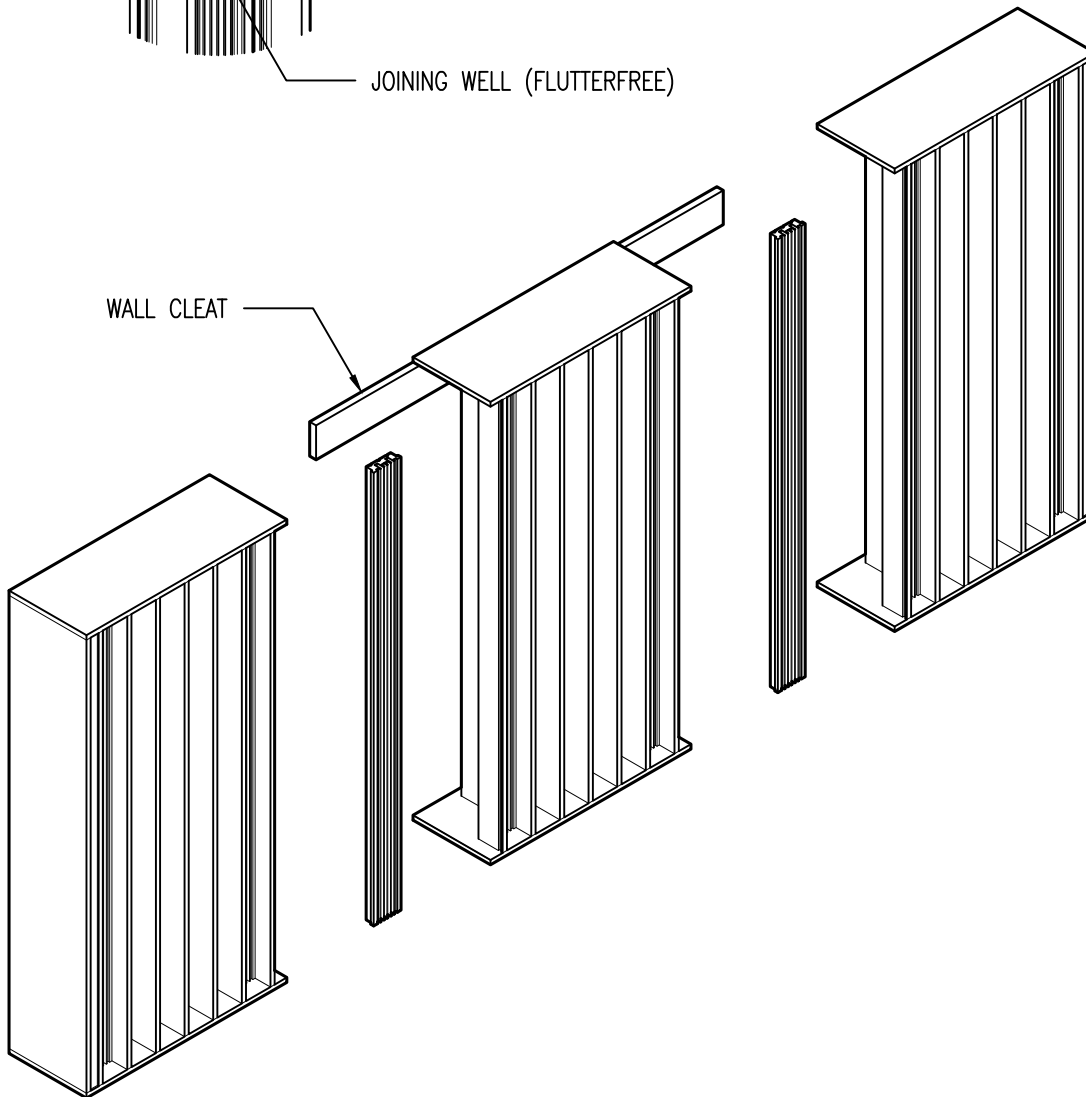
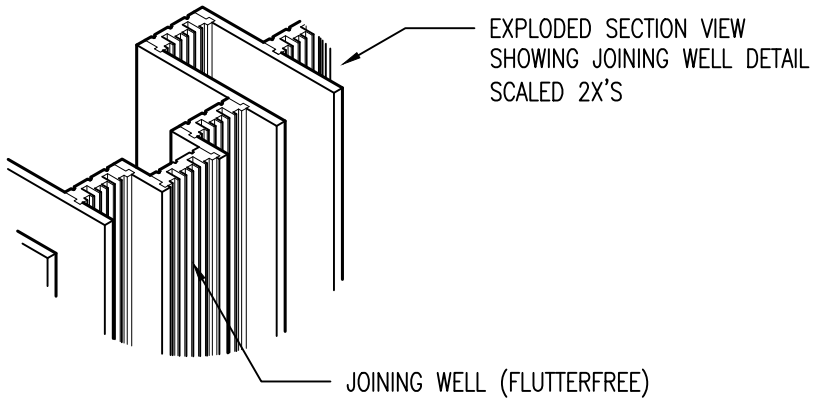

99 SOUTH STREET, PASSAIC, NJ 07055
(p) 973-916-1166 (e) estimating@rpgacoustic.com

Title: RPG DIFFRACTAL 4X2 JOINING WELL
WALL MOUNTING

Proj: RPG PRODUCT

Date: 8/22/22

By: CNN

Scale: NTS

Comments:

Path: F:\Project Mount - RPG_RPG PRODUCTS\ALL PRODUCTS DRAWING\DIFFRACTAL\1-AutoCAD Drawings\Mounting\Diffraction Mounting R3

ATTACH UNITS TO CEILING MOUNTED
CLEATS USING TRIM HEAD SCREWS TO
MINIMIZE PENETRATIONS IN THE SIDES
OF THE UNITS. USE WOOD PUTTY TO
FILL HOLES.

CAULK EDGES TO
PREVENT VIBRATIONS

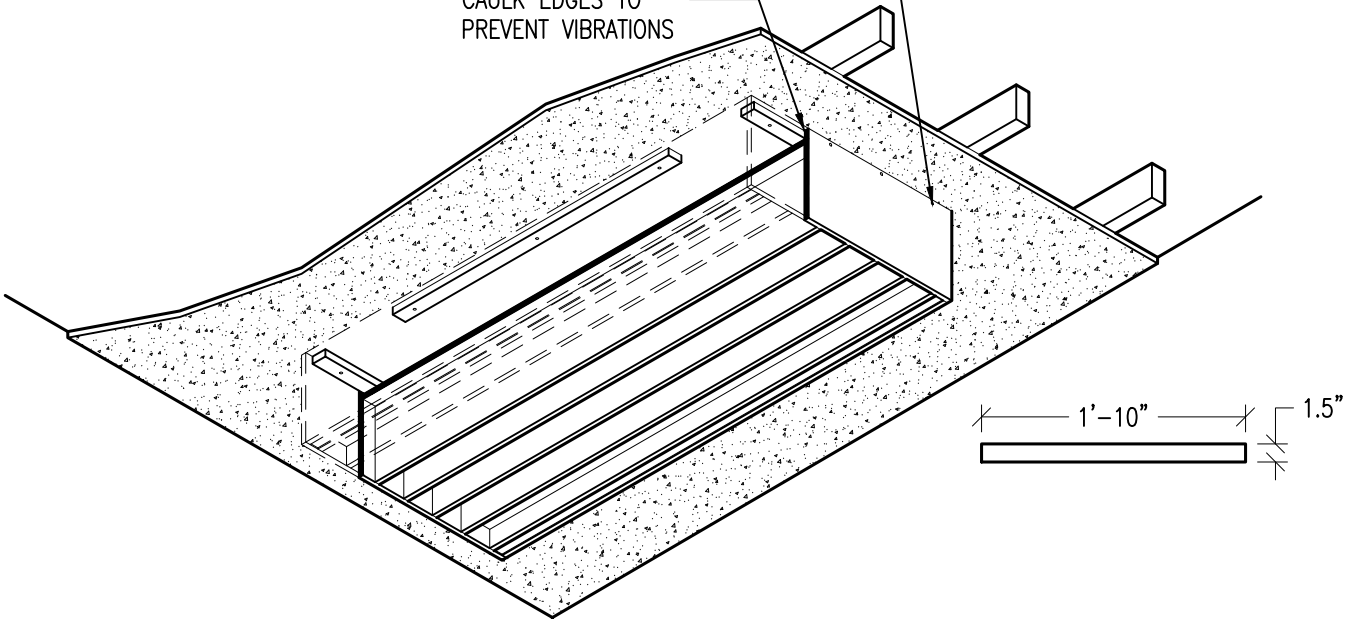

SECTIONAL ISOMETRIC VIEW
SHOWING CLEAT LOCATIONS
FOR CEILING MOUNTING

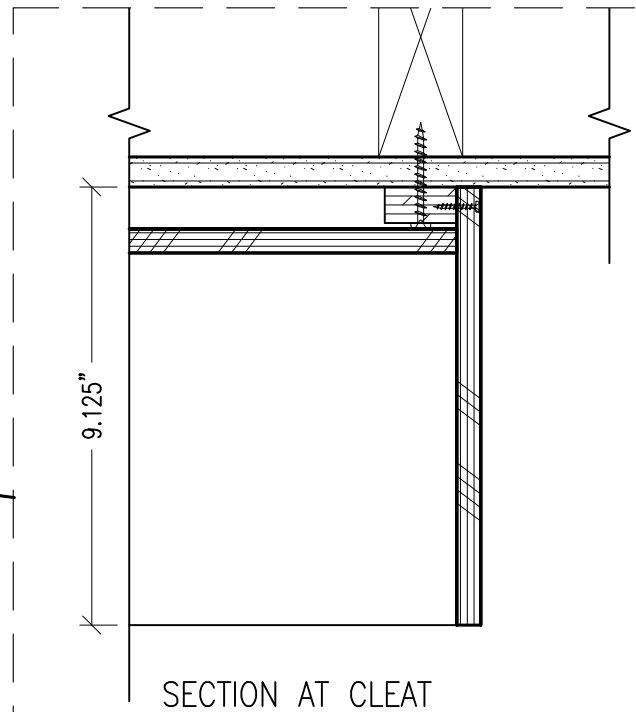

SECTION AT CLEAT



99 SOUTH STREET, PASSAIC, NJ 07055
(p) 973-916-1166 (e) estimating@rpgacoustic.com

Title: RPG DIFFRACTAL CEILING MOUNTING

Proj: RPG PRODUCT

Date: 8/22/22

By: CNN

Scale: NTS

Comments:

Path: F:\Project Mgmt - RPG\RPG PRODUCTS\ALL PRODUCTS DRAWING\DIFFRACTAL\1-AutoCAD Drawings\Mounting\Diffraction Mounting R3

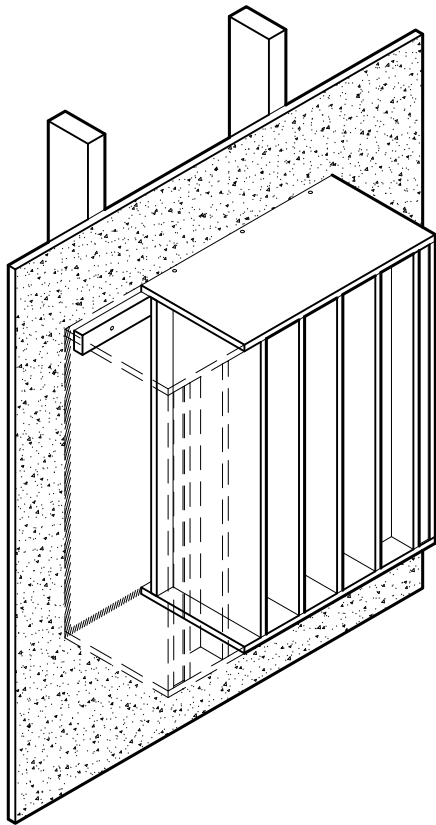

SECTIONAL ISOMETRIC VIEW
SHOWING CLEAT LOCATION

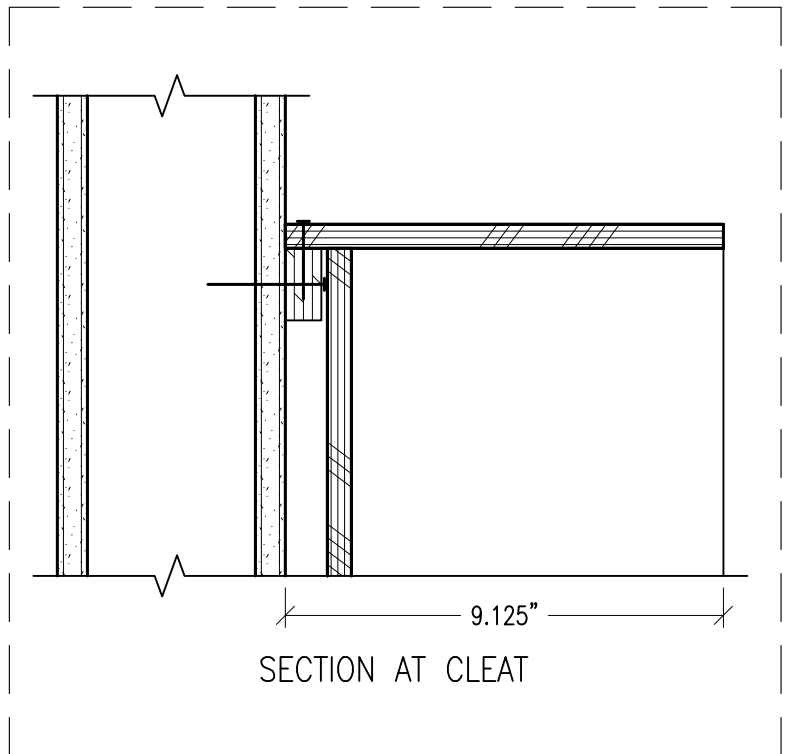
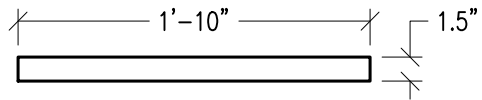

SECTION AT CLEAT



99 SOUTH STREET, PASSAIC, NJ 07055
(p) 973-916-1166 (e) estimating@rpgacoustic.com

Title: RPG DIFFRACTAL WALL MOUNTING
WOOD CLEAT

Proj: RPG PRODUCT

Date: 8/22/22

By: CNN

Scale: NTS

Comments:

Path: F:\Project Mgmt - RPG\PROJECTS\ALL PRODUCTS DRAWING\DIFFRACTAL\1-AutoCAD Drawings\Mounting\Diffraction Mounting R3

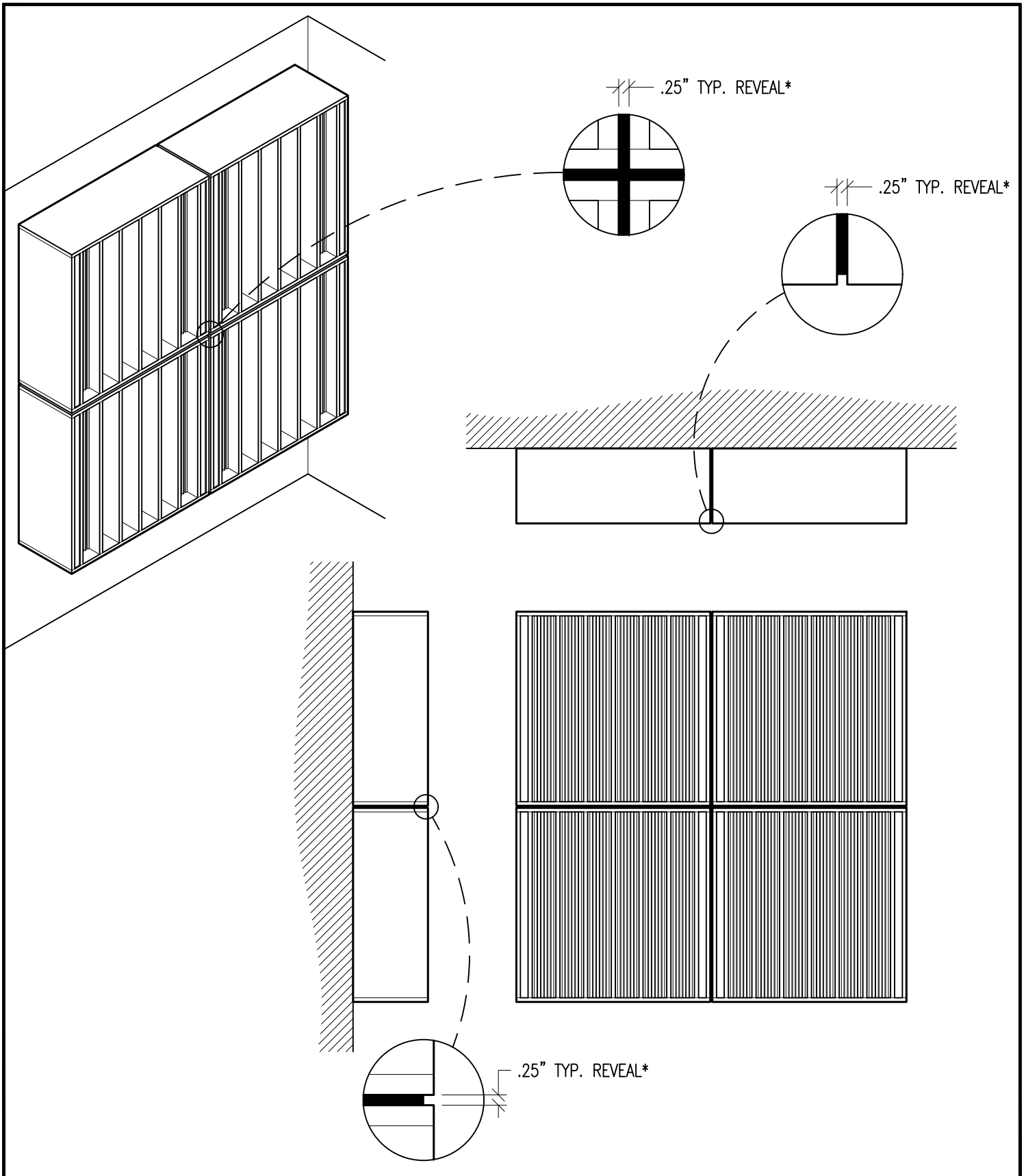

99 SOUTH STREET, PASSAIC, NJ 07055
 (p) 973-916-1166 (e) estimating@rpgacoustic.com

Title: RPG DIFFRACTAL 2X2 EE ARRAY
 WALL MOUNTING

Proj: RPG PRODUCT

Date: 8/22/22

By: CNN

Scale: NTS

Comments:

Path: F:\Project Mgmt - RPG\RPG PRODUCTS\ALL PRODUCTS DRAWING\DIFFRACTAL\1-AutoCAD Drawings\Mounting\Diffraction Mounting R3

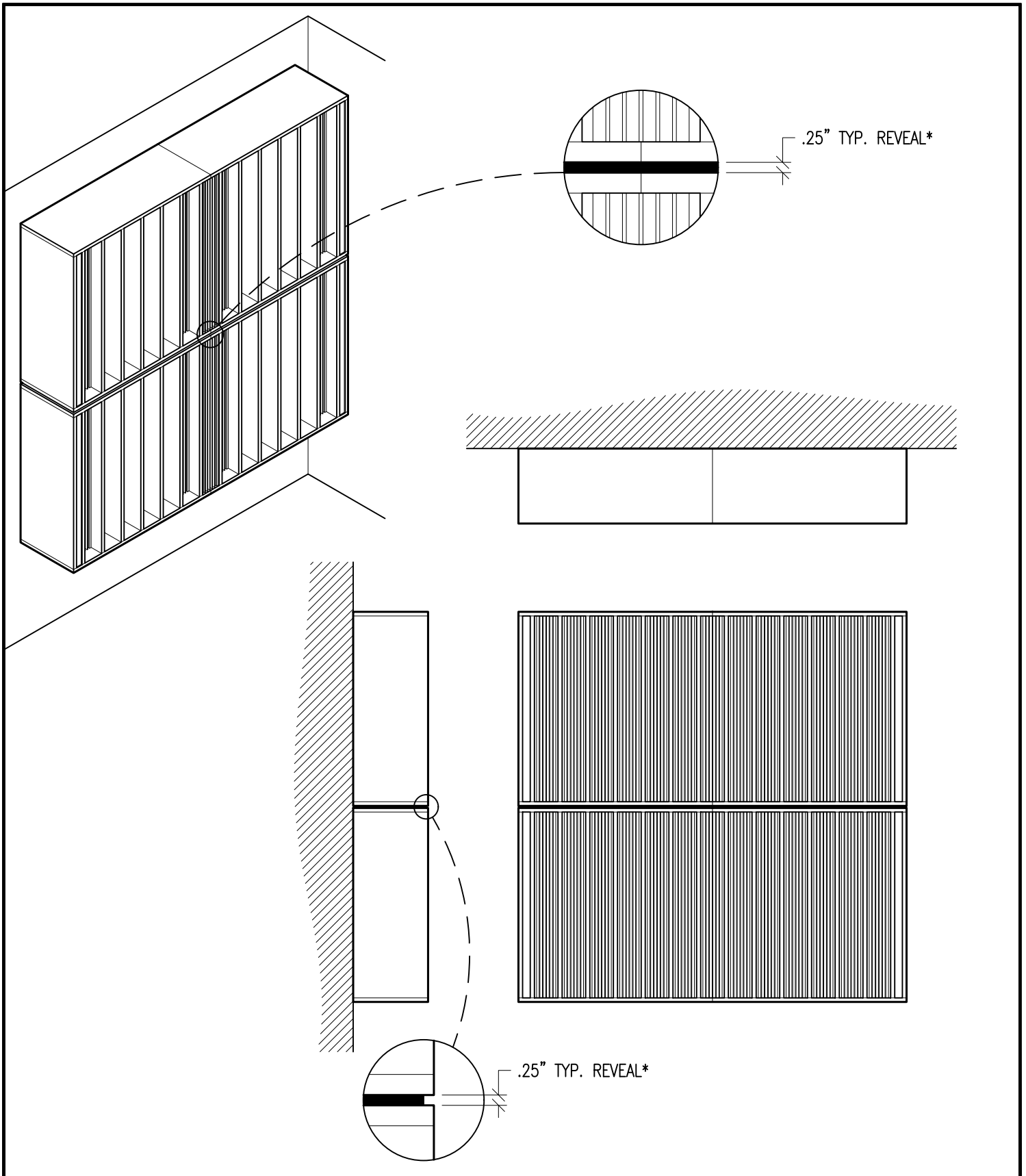

99 SOUTH STREET, PASSAIC, NJ 07055
 (p) 973-916-1166 (e) estimating@rpgacoustic.com

Title: RPG DIFFRACTAL 2X2 EJ ARRAY
 WALL MOUNTING

Proj: RPG PRODUCT

Date: 8/22/22

By: CNN

Scale: NTS

Comments:

Path: F:\Project Mgmt - RPG\PROJECTS\ALL PRODUCTS DRAWING\DIFFRACTAL\1-AutoCAD Drawings\Mounting\Diffraction Mounting R3

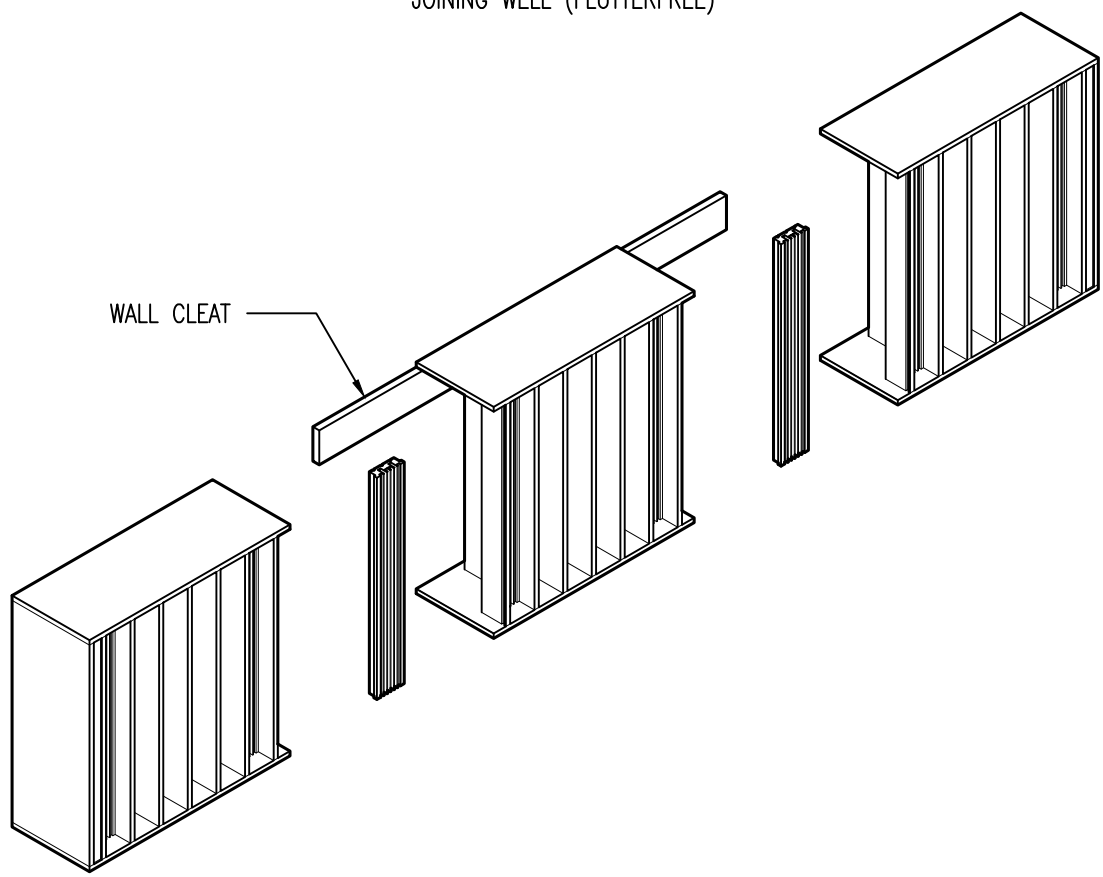
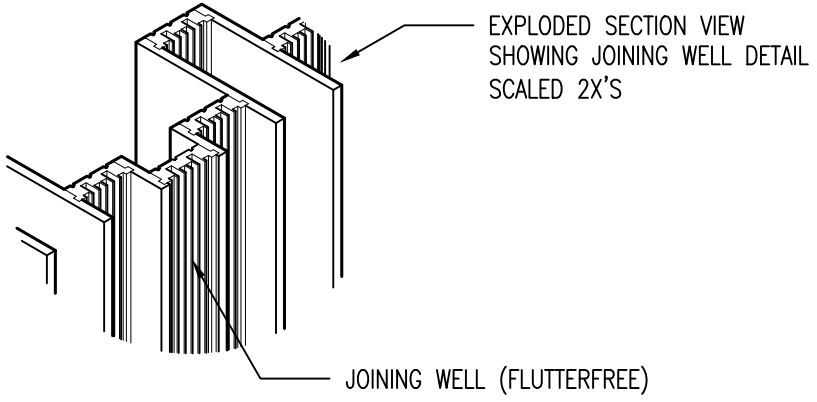

99 SOUTH STREET, PASSAIC, NJ 07055
(p) 973-916-1166 (e) estimating@rpgacoustic.com

Title: RPG DIFFRACTAL 2X2 JOINING WELL
WALL MOUNTING

Proj: RPG PRODUCT

Date: 8/22/22 By: CNN Scale: NTS

Path: F:\Project Mount - RPG_RPG PRODUCTS\ALL PRODUCTS DRAWING\DIFFRACTAL\1-AutoCAD Drawings\Mounting\Diffraction Mounting R3

Comments:

