

SW ISOMETRIC

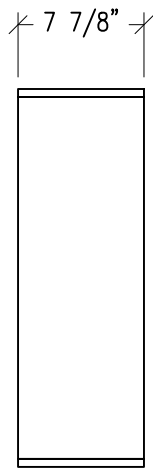

TOP



SIDE

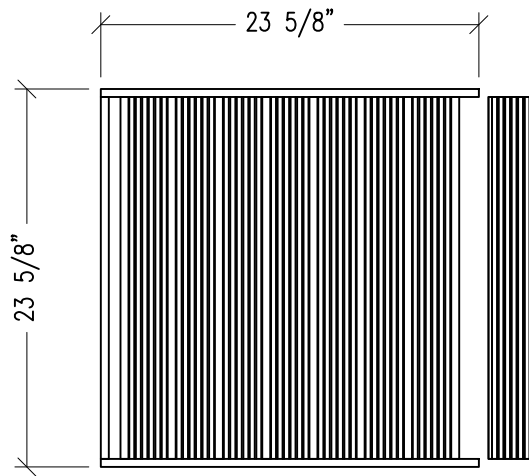

FRONT



99 SOUTH STREET, PASSAIC, NJ 07055
 (P) 973-916-1166 (E) estimating@rpgacoustic.com

Title: MODFRACTAL 2'x2'
 CUTSHEET

Label: EJO

Proj:

JOB#:

Line Item:

QTY.

Date: 08/22/22

By: ACT

Scale: NTS

#

Path: F:\Project Mgmt - RPG\PROJECTS\ALL PRODUCTS DRAWING\MODR_Modfractal\1- AutoCAD Drawings\Cutsheet\For Approval Cut Sheets\MODR R1

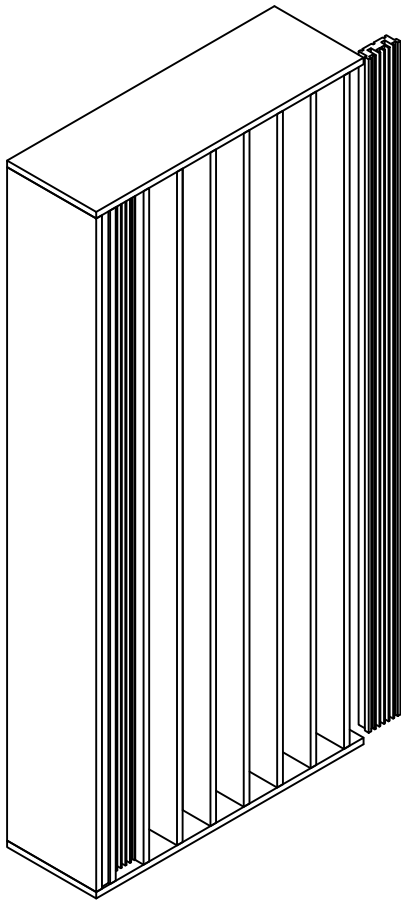

SW ISOMETRIC



TOP

7 7/8"

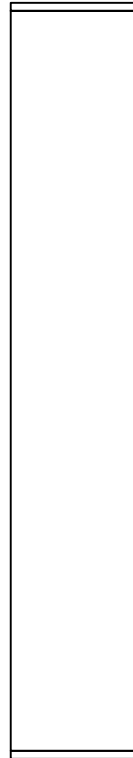

SIDE

23 5/8"

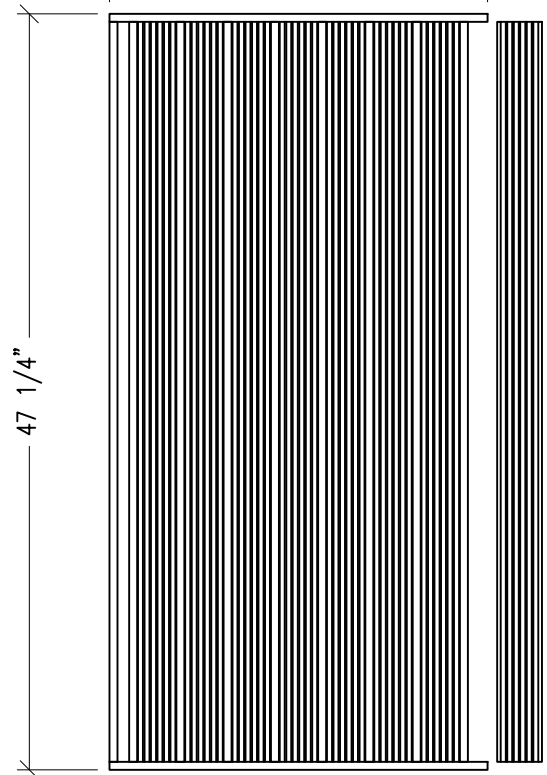

FRONT



99 SOUTH STREET, PASSAIC, NJ 07055
 (P) 973-916-1166 (E) estimating@rpgacoustic.com

Title: MODFRACTAL 4'x2' CUTSHEET		Label: EJO	
Proj:	JOB#:	Line Item:	QTY.
Date: 08/22/22	By: ACT	#	
Path: F:\Project Mgmt - RPG\PROJECTS\ALL PRODUCTS DRAWING\MODR_Modfractal\AutoCAD Drawings\Cutsheet\For Approval Cut Sheets\MODR R1		Scale: NTS	

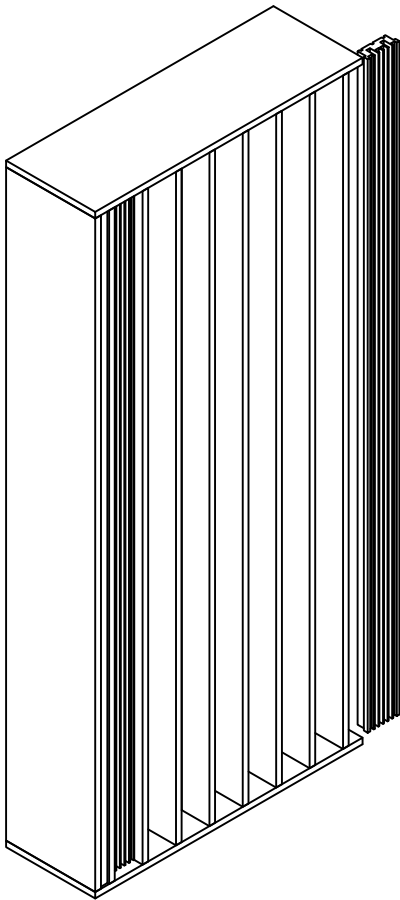

SW ISOMETRIC



TOP

7 7/8"



SIDE

23 5/8"

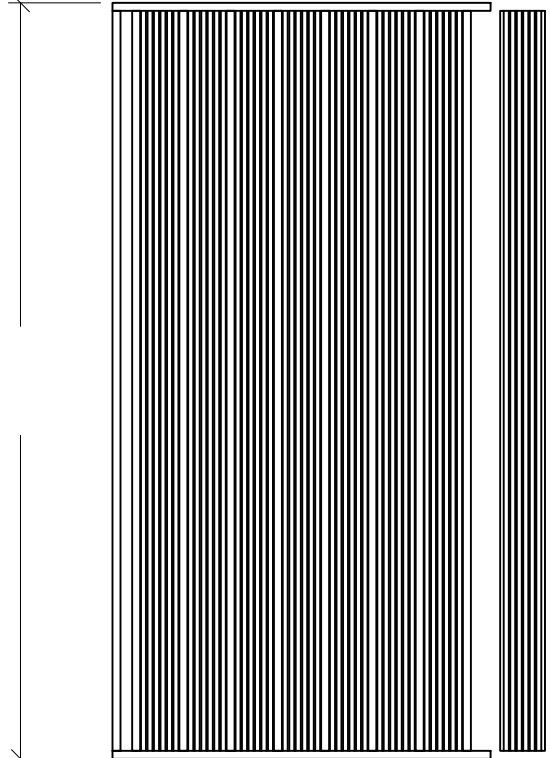

FRONT



99 SOUTH STREET, PASSAIC, NJ 07055
 (P) 973-916-1166 (E) estimating@rpgacoustic.com

Title: MODFRACTAL CUTSHEET		Label: EJO	
Proj:	JOB#:	Line Item:	QTY.
Date: 08/22/22	By: ACT	#	
Path: F:\Project Mgmt - RPG\PROJECTS\ALL PRODUCTS DRAWING\MODR_Modfractal\AutoCAD Drawings\Cutsheet\For Approval Cut Sheets\MODR R1		Scale: NTS	

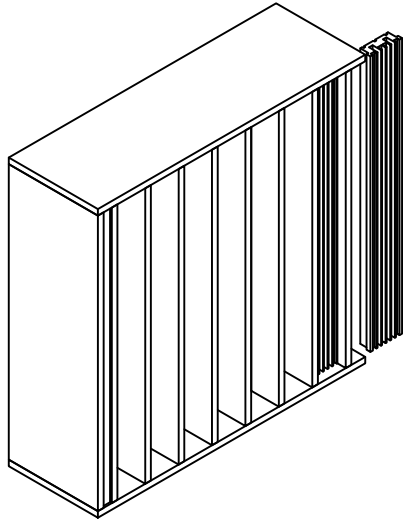

SW ISOMETRIC



TOP

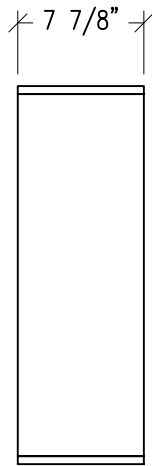

SIDE

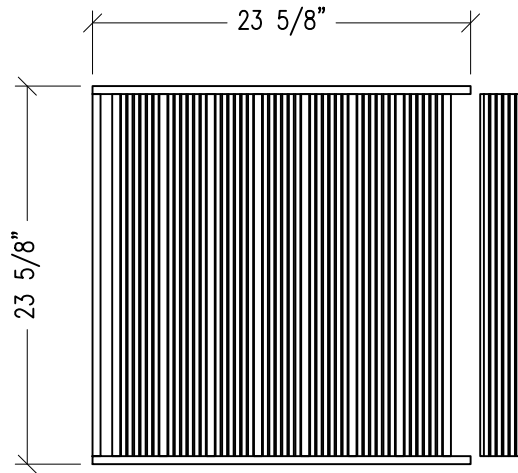

FRONT



99 SOUTH STREET, PASSAIC, NJ 07055
 (P) 973-916-1166 (E) estimating@rpgacoustic.com

Title: MODFRACTAL 2'x2' CUTSHEET		Label: EJ1	
Proj:	JOB#:	Line Item:	QTY.
Date: 08/22/22	By: ACT	#	
Path: F:\Project Mgmt - RPG\...RPG PRODUCTS\ALL PRODUCTS DRAWING\MODR_Modfractal\ - AutoCAD Drawings\Cutsheet\For Approval Cut Sheets\MODR R1			
Scale: NTS			

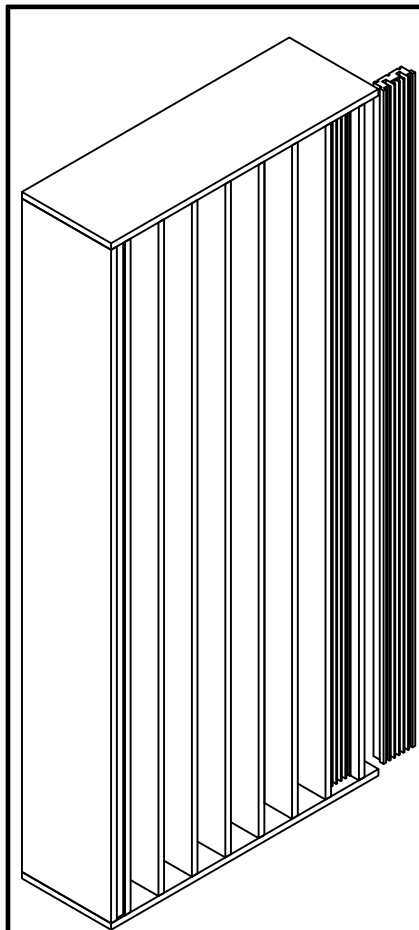

SW ISOMETRIC



TOP

7 7/8"

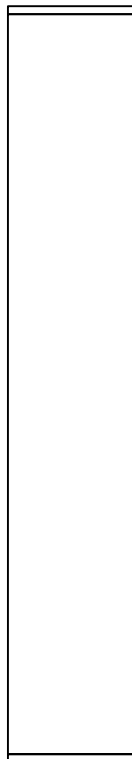

SIDE

23 5/8"

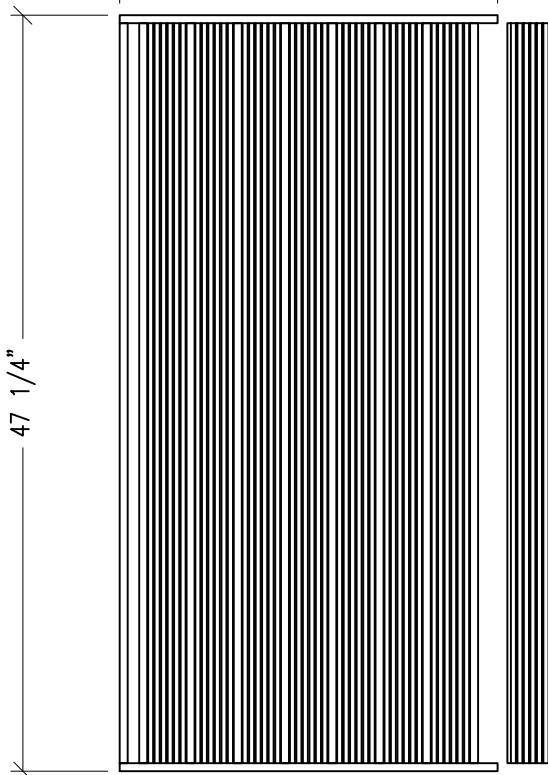

FRONT



99 SOUTH STREET, PASSAIC, NJ 07055
 (P) 973-916-1166 (E) estimating@rpgacoustic.com

Title: MODFRACTAL 4'x2' CUTSHEET		Label: EJ1	
Proj:	JOB#:	Line Item:	QTY.
Date: 08/22/22	By: ACT	#	
Path: F:\Project Mgmt - RPG\PROJECTS\ALL PRODUCTS DRAWING\MODR_Modfractal\AutoCAD Drawings\Cutsheet\For Approval Cut Sheets\MODR R1			
Scale: NTS			

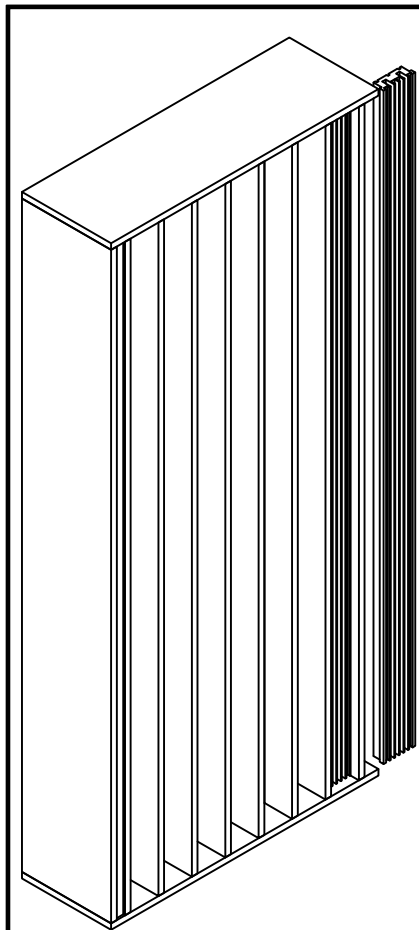

SW ISOMETRIC

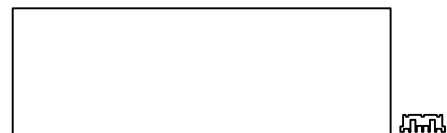

TOP

7 7/8"

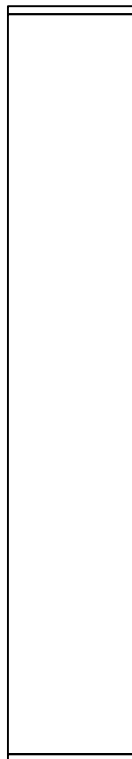

SIDE

23 5/8"

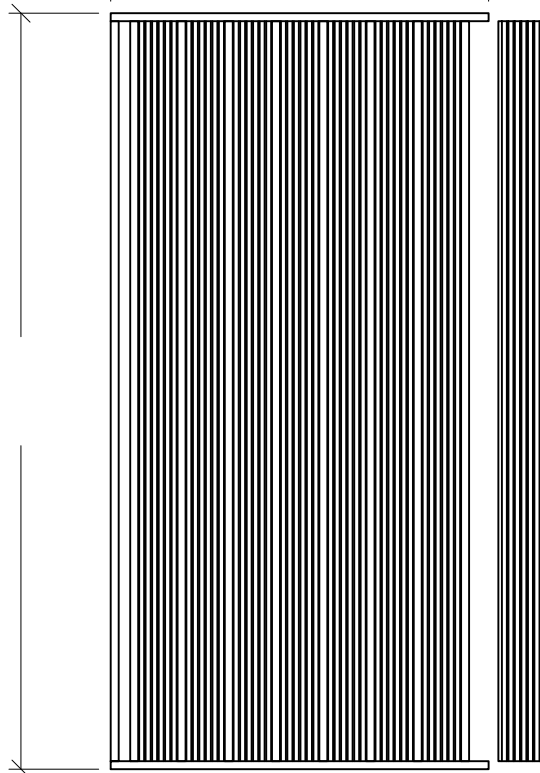

FRONT



99 SOUTH STREET, PASSAIC, NJ 07055
 (P) 973-916-1166 (E) estimating@rpgacoustic.com

Title: MODFRACTAL CUTSHEET		Label: EJ1	
Proj:	JOB#:	Line Item:	QTY.
Date: 08/22/22	By: ACT	#	
Path: F:\Project Mgmt - RPG\PRODUCTS\ALL PRODUCTS DRAWING\MODR_Modfractal\AutoCAD Drawings\Cutsheet\For Approval Cut Sheets\MODR R1		Scale: NTS	

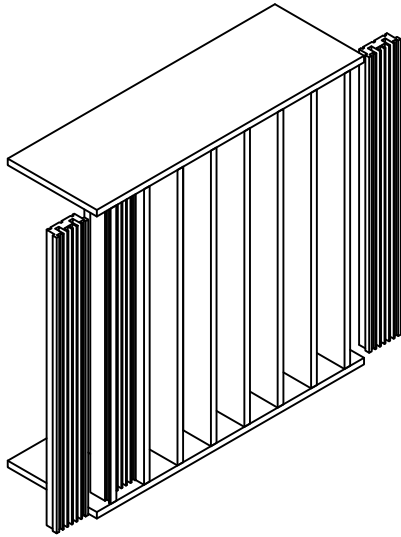

SW ISOMETRIC

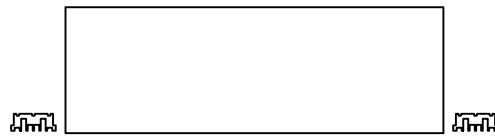

TOP

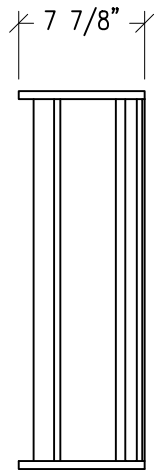

SIDE

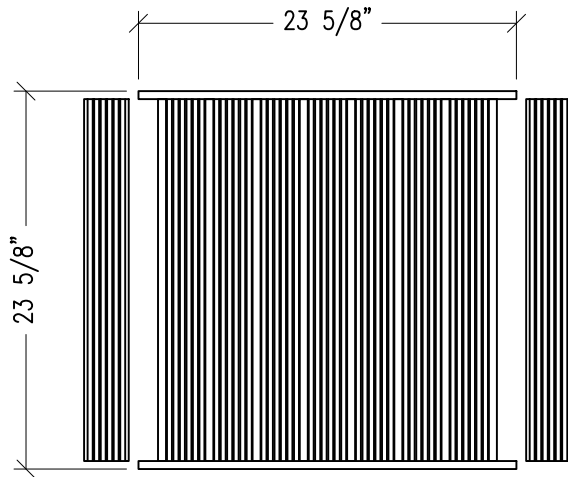

FRONT



99 SOUTH STREET, PASSAIC, NJ 07055
 (P) 973-916-1166 (E) estimating@rpgacoustic.com

Title: MODFRACTAL 2'x2' CUTSHEET		Label: JJ	
Proj:	JOB#:	Line Item:	QTY.
Date: 08/22/22	By: ACT	#	
Path: F:\Project Mgmt - RPG\...RPG PRODUCTS\ALL PRODUCTS DRAWING\MODR_Modfractal\1- AutoCAD Drawings\Cutsheet\For Approval Cut Sheets\MODR R1			
Scale: NTS			

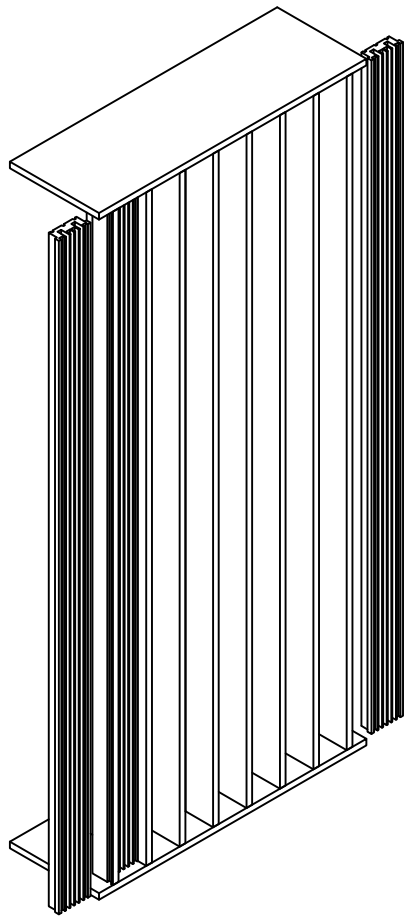

SW ISOMETRIC



TOP

7 7/8"

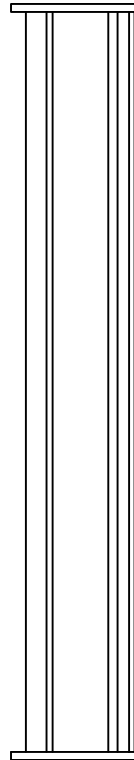

SIDE

23 5/8"

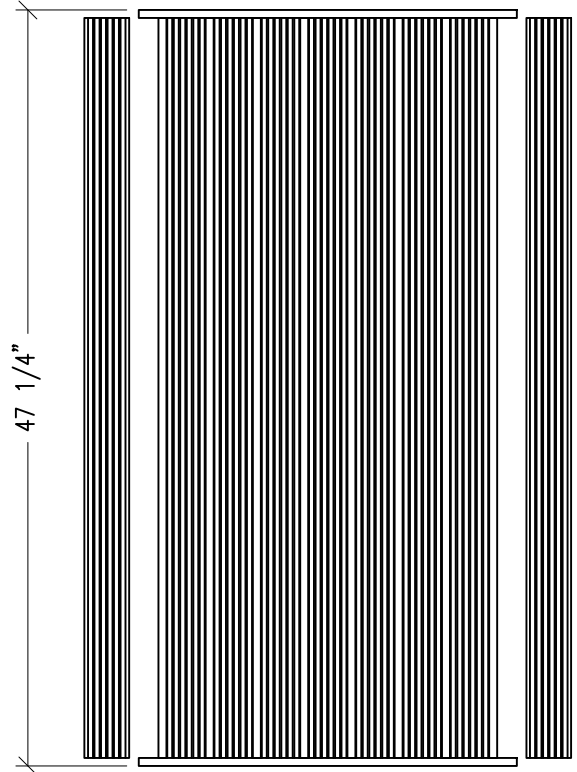

FRONT

47 1/4"



99 SOUTH STREET, PASSAIC, NJ 07055
 (P) 973-916-1166 (E) estimating@rpgacoustic.com

Title: MODFRACTAL 4'x2' CUTSHEET		Label: JJ	
Proj:	JOB#:	Line Item:	QTY.
Date: 08/22/22	By: ACT	#	
Path: F:\Project Mgmt - RPG\PROJECTS\ALL PRODUCTS DRAWING\MODR_Modfractal\AutoCAD Drawings\Cutsheet\For Approval Cut Sheets\MODR R1		Scale: NTS	

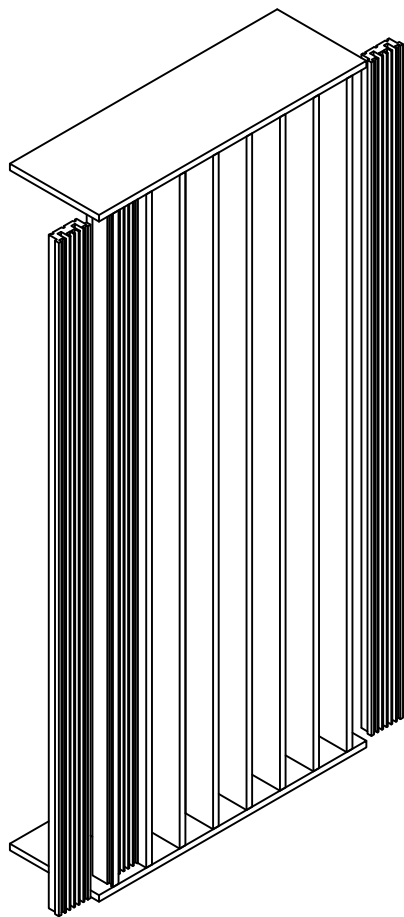

SW ISOMETRIC



TOP

7 7/8"



SIDE

23 5/8"

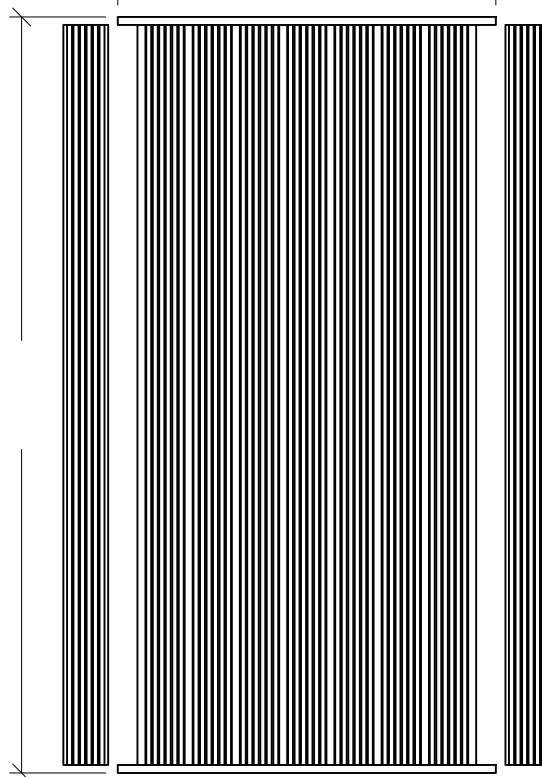

FRONT



99 SOUTH STREET, PASSAIC, NJ 07055
 (P) 973-916-1166 (E) estimating@rpgacoustic.com

Title: MODFRACTAL CUTSHEET

Label: JJ

Proj:

JOB#:

Line Item:

QTY.

Date: 08/22/22

By: ACT

Scale: NTS

#

Path: F:\Project Mgmt - RPG\PROJECTS\ALL PRODUCTS DRAWING\MODR_Modfractal\AutoCAD Drawings\Cutsheet\For Approval Cut Sheets\MODR R1

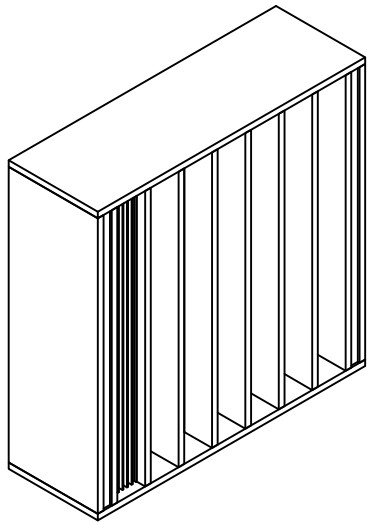

SW ISOMETRIC



TOP

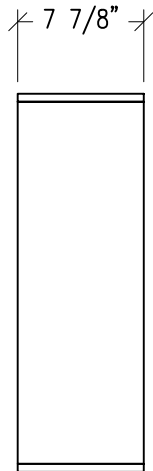

SIDE

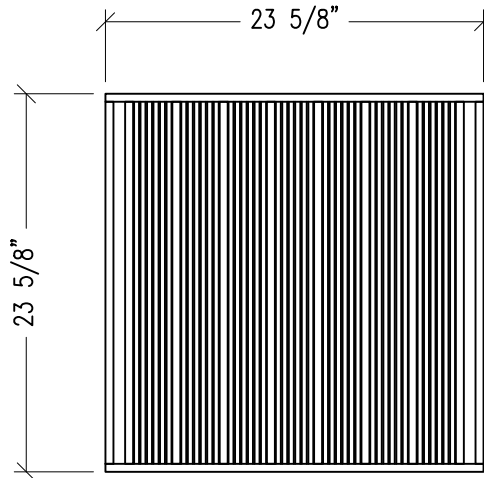

FRONT



ACOUSTICAL SYSTEMS - LLC
 99 SOUTH STREET, PASSAIC, NJ 07055
 (P) 973-916-1166 (E) estimating@rpgacoustic.com

Title: MODFRACTAL 2'x2'
 CUTSHEET

Label: EE

Proj:

JOB#:

Line Item:

QTY.

Date: 08/22/22

By: ACT

Scale: NTS

#

Path: F:\Project Mgmt - RPG\PROJECTS\ALL PRODUCTS DRAWING\MODR_Modfractal\AutoCAD Drawings\Cutsheet\For Approval Cut Sheets\MODR R1

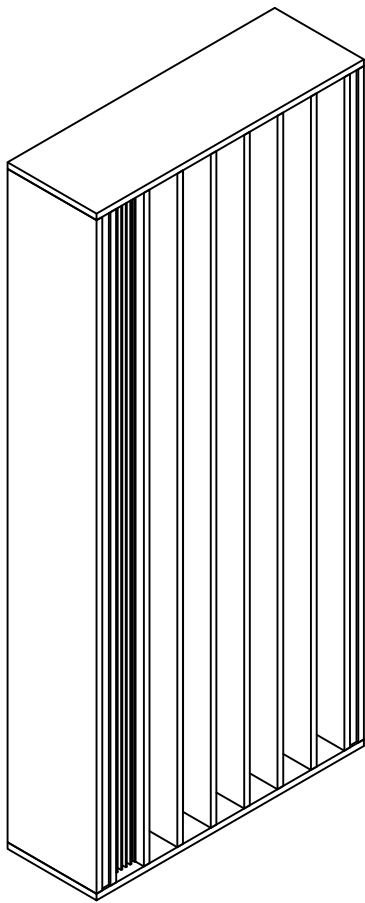

SW ISOMETRIC

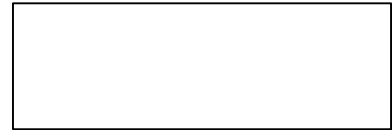

TOP

7 7/8"

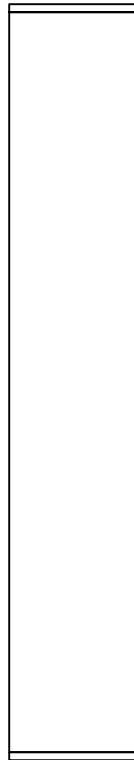

SIDE

23 5/8"

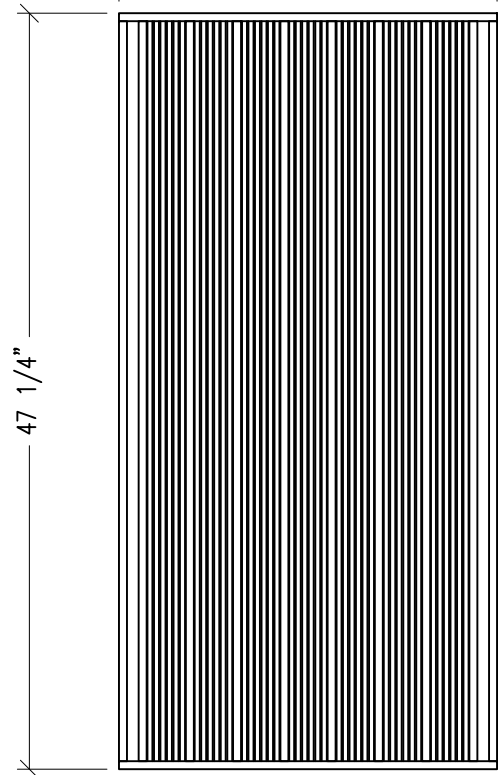

FRONT

47 1/4"



99 SOUTH STREET, PASSAIC, NJ 07055
 (P) 973-916-1166 (E) estimating@rpgacoustic.com

Title: MODFRACTAL 4'x2' CUTSHEET		Label: EE	
Proj:	JOB#:	Line Item:	QTY.
Date: 08/22/22	By: ACT	#	
Path: F:\Project Mgmt - RPG\PROJECTS\ALL PRODUCTS DRAWING\MODR_Modfractal\AutoCAD Drawings\Cutsheet\For Approval Cut Sheets\MODR R1		Scale: NTS	

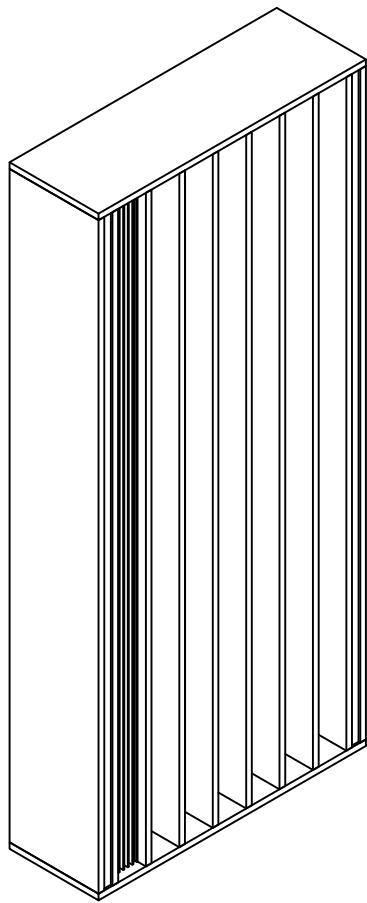

SW ISOMETRIC

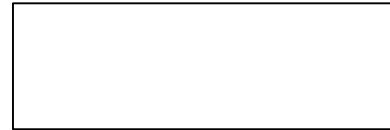

TOP

7 7/8"

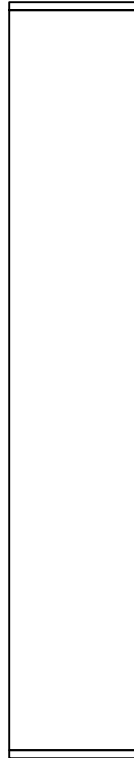

SIDE

23 5/8"

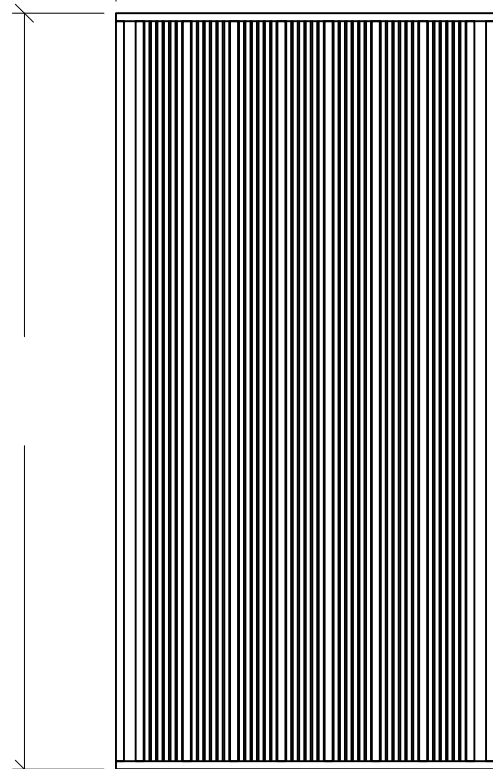

FRONT



ACOUSTICAL SYSTEMS - LLC
99 SOUTH STREET, PASSAIC, NJ 07055
(P) 973-916-1166 (E) estimating@rpgacoustic.com

Title: MODFRACTAL CUTSHEET		Label: EE	
Proj:	JOB#:	Line Item:	QTY.
Date: 08/22/22	By: ACT	#	
Path: F:\Project Mgmt - RPG\PROJECTS\ALL PRODUCTS DRAWING\MODR_Modfractal\AutoCAD Drawings\Cutsheet\For Approval Cut Sheets\MODR R1		Scale: NTS	