

99 SOUTH STREET, PASSAIC, NJ 07055
(p) 973-916-1166 (e) estimating@rpgacoustic.com

Title: RPG MODFFRACTAL (2X2)
JOINING WELL

Proj: RPG PRODUCT

Date: 8/22/2022

By: CNN

Scale: 3/4" = 1'-0"

Comments:

Path: F:\Project Mgmt - RPG\ - RPG PRODUCTS\ALL PRODUCTS DRAWING\MODR_Modfractal\1 - AutoCAD Drawings\Mounting

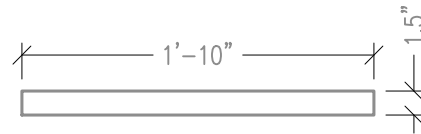
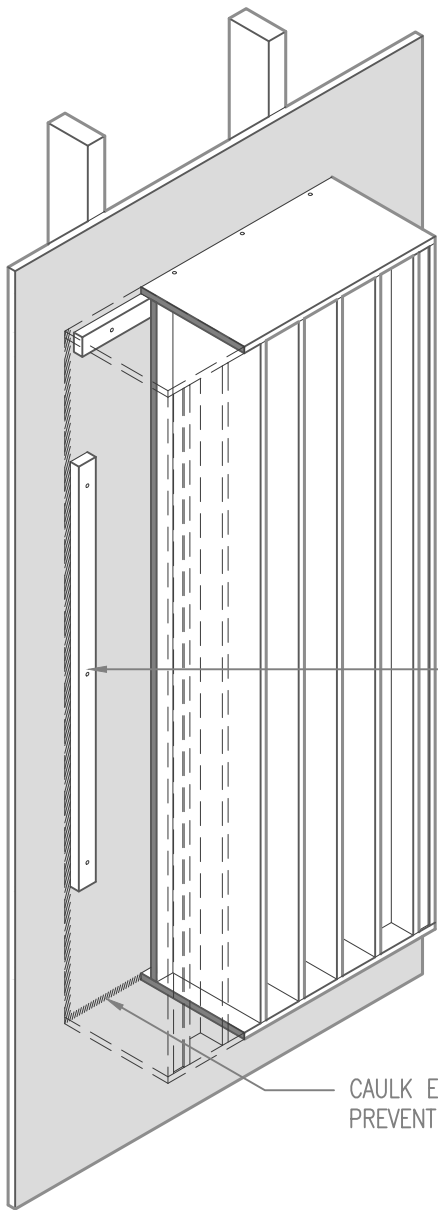

(1) 3/4" PLYWOOD CLEAT WILL BE PROVIDED FOR EACH UNIT

ADDITIONAL CLEATS MAY BE REQUIRED FOR UNITS OVER 48" TALL

CAULK EDGES TO PREVENT VIBRATION

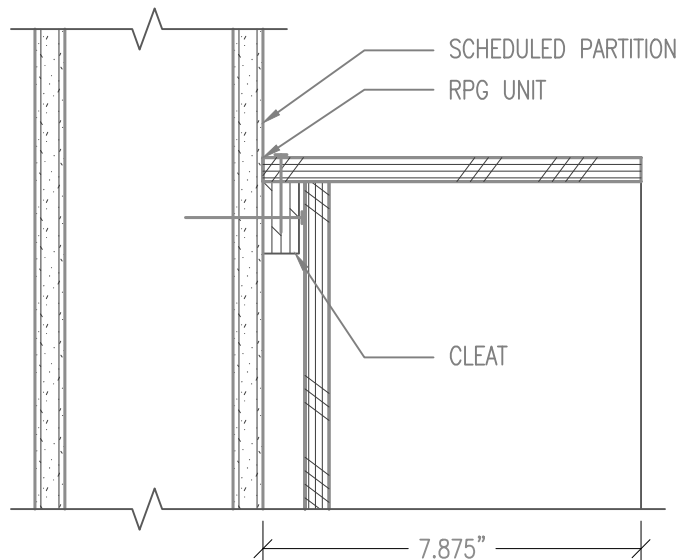

99 SOUTH STREET, PASSAIC, NJ 07055
 (p) 973-916-1166 (e) estimating@rpgacoustic.com

Title: RPG MODFFRACTAL (4X2)
 CLEAT MOUNTING

Proj: RPG PRODUCT

Date: 8/22/2022

By: CNN

Scale: NTS

Path: F:\Project Mgmt - RPG_-RPG PRODUCTS\ALL PRODUCTS DRAWING\MODR_Modfractal\1- AutoCAD Drawings\Mounting

Comments:

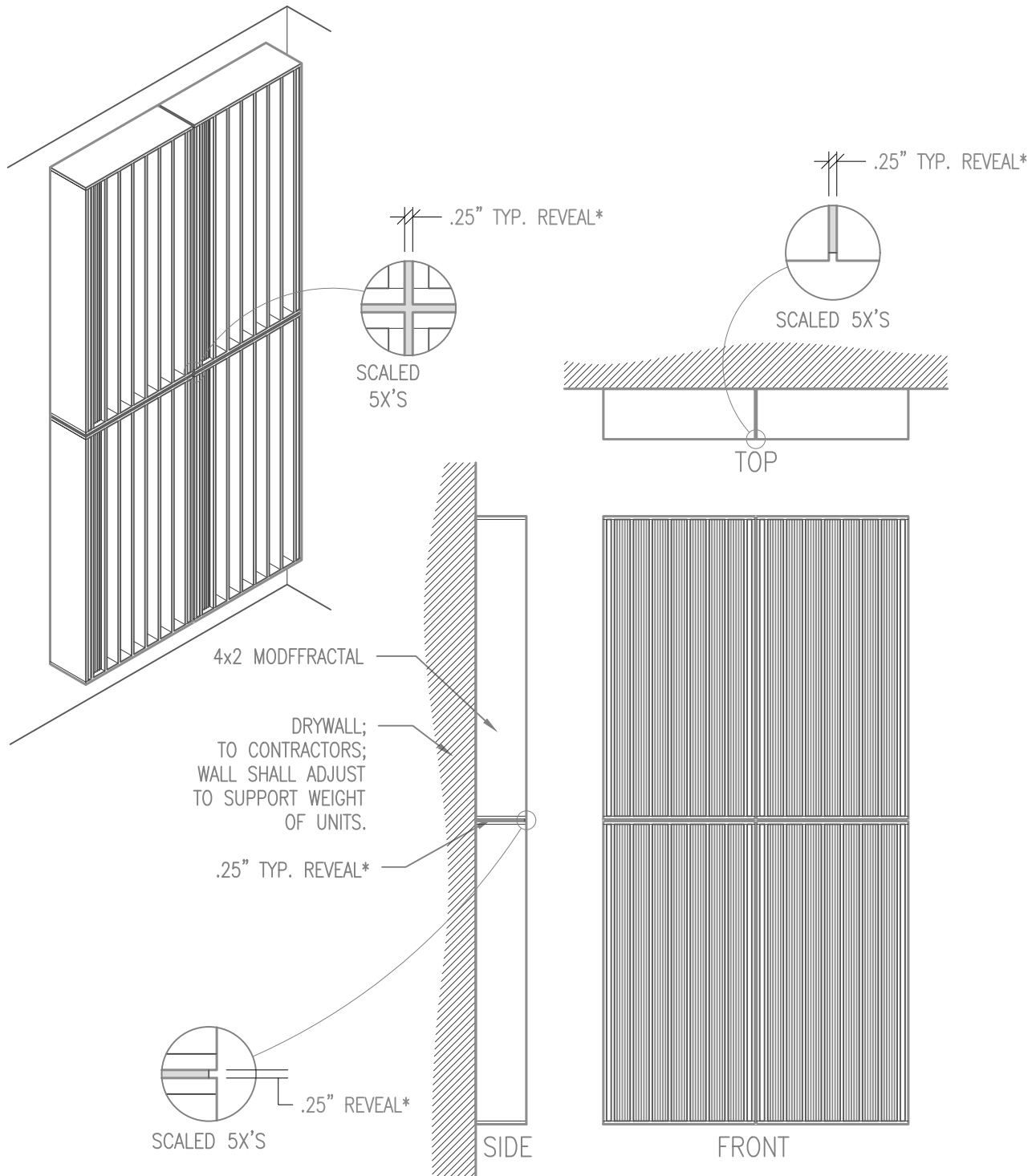

* SPACER WITHIN REVEAL IS PROVIDED BY OTHERS.



99 SOUTH STREET, PASSAIC, NJ 07055
 (p) 973-916-1166 (e) estimating@rpgacoustic.com

Title: RPG MODFFRACTAL (4X2)
 EE ARRAY

Proj: RPG PRODUCT

Date: 8/22/2022 By: CNN Scale: 1/2" = 1'-0"

Path: F:\Project Mgmt - RPG\ - RPG PRODUCTS \ALL PRODUCTS DRAWING\MODR_Modffractal\1- AutoCAD Drawings\Mounting

Comments:

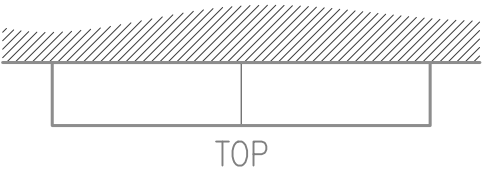
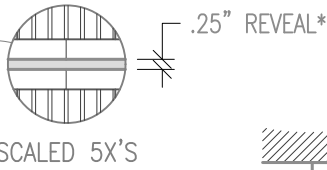
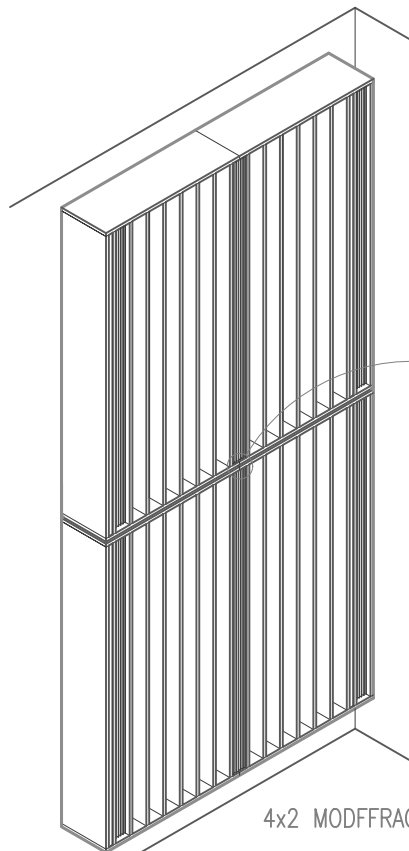

4x2 MODFFRACTAL

DRYWALL;
TO CONTRACTORS;
WALL SHALL ADJUST
TO SUPPORT WEIGHT
OF UNITS.

.25" TYP. REVEAL*

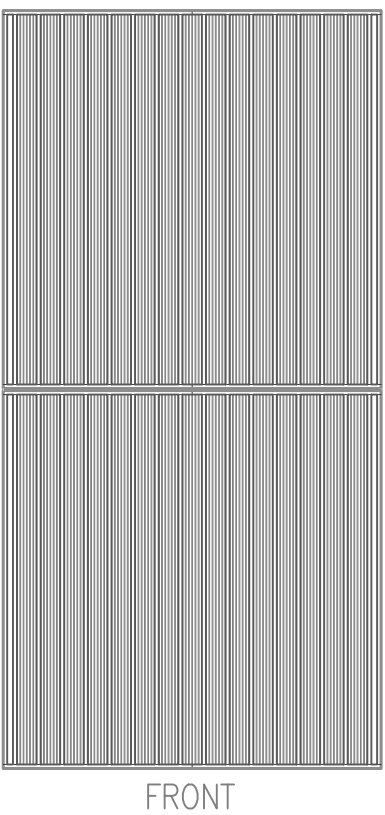
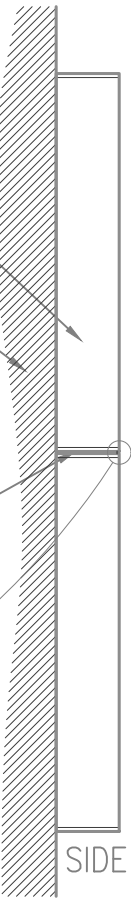
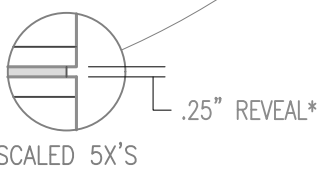

* SPACER WITHIN
REVEAL IS PROVIDED
BY OTHERS.



99 SOUTH STREET, PASSAIC, NJ 07055
(p) 973-916-1166 (e) estimating@rpgacoustic.com

Title: RPG MODFFRACTAL (4X2)
EJ ARRAY

Proj: RPG PRODUCT

Date: 8/22/2022 By: CNN Scale: 1/2" = 1'-0"

Path: F:\Project Mgmt - RPG\ - RPG PRODUCTS\ALL PRODUCTS DRAWING\MODR_Modfractal\1 - AutoCAD Drawings\Mounting

Comments:

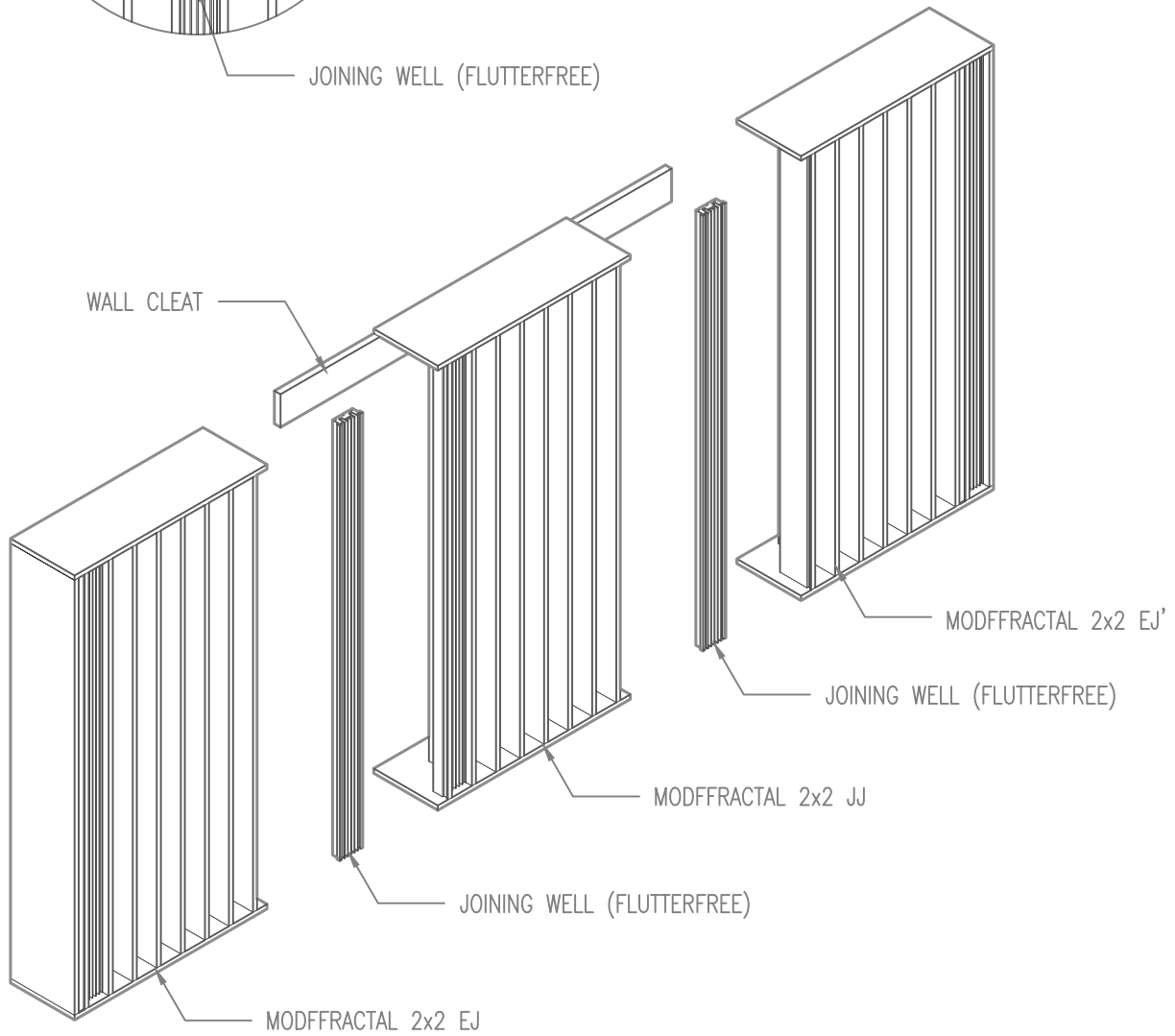
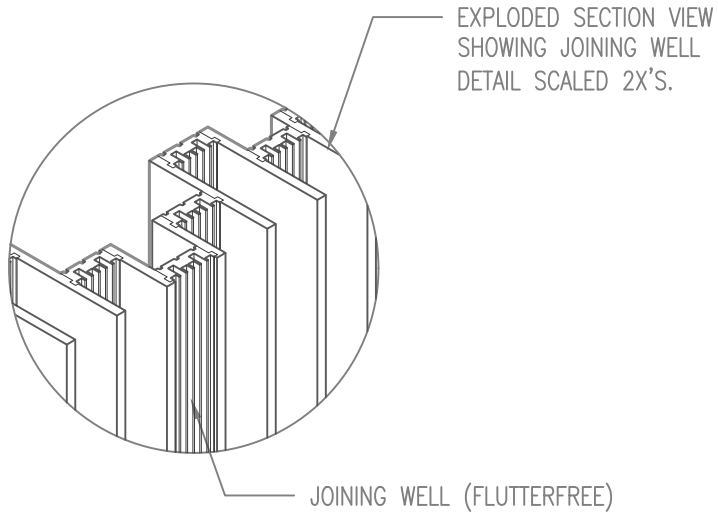

99 SOUTH STREET, PASSAIC, NJ 07055
(p) 973-916-1166 (e) estimating@rpgacoustic.com

Title: RPG MODFFRACTAL (4X2)
JOINING WELL

Proj: RPG PRODUCT

Date: 8/22/2022

By: CNN

Scale: 3/4" = 1'-0"

Comments:

Path: F:\Project Mgmt - RPG\ - RPG PRODUCTS\ALL PRODUCTS DRAWING\MODR_Modfractal\1 - AutoCAD Drawings\Mounting

ATTACH UNITS TO CEILING MOUNTED CLEATS USING TRIM HEAD SCREWS TO MINIMIZE PENETRATIONS IN THE SIDES OF THE UNITS. USE WOOD PUTTY TO FILL HOLES.

CAULK EDGES TO PREVENT VIBRATIONS

ADDITIONAL CLEATS MAY BE REQUIRED FOR UNITS OVER 48" TALL.

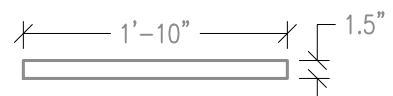
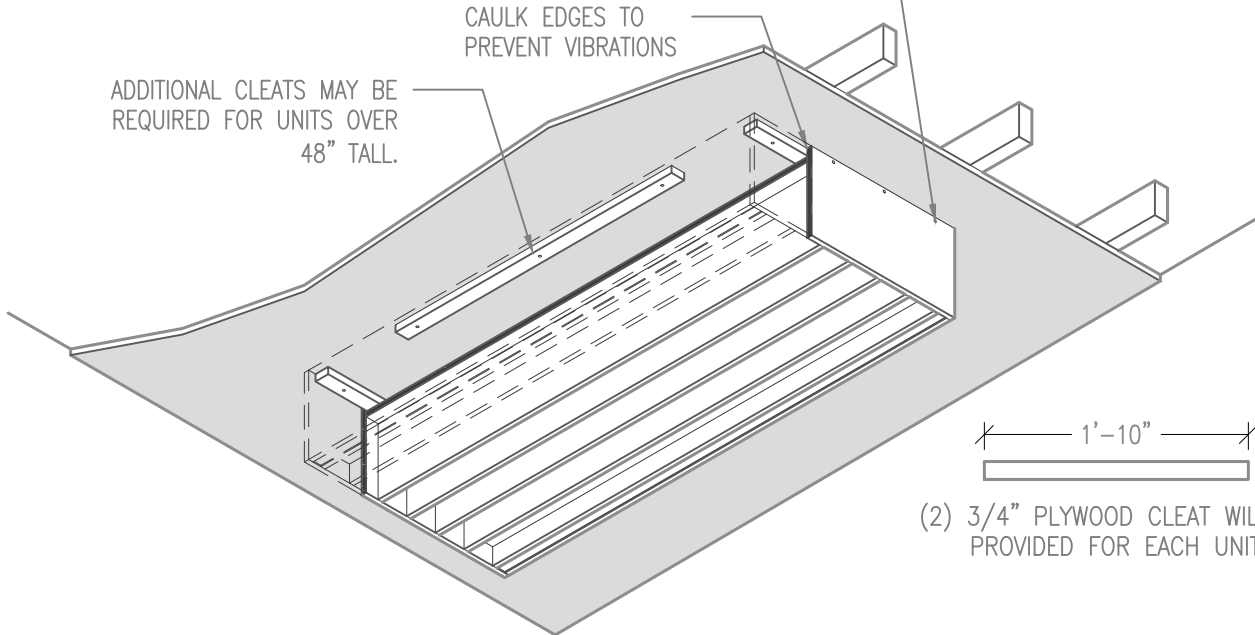

(2) 3/4" PLYWOOD CLEAT WILL BE PROVIDED FOR EACH UNIT

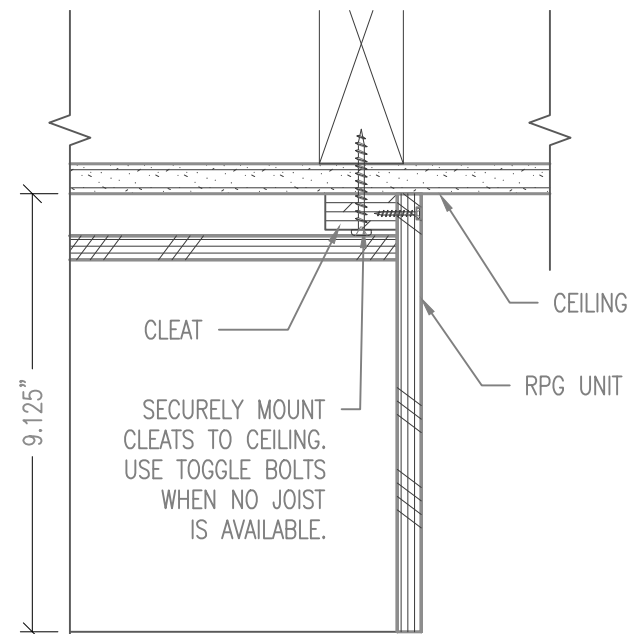

SECURELY MOUNT CLEATS TO CEILING. USE TOGGLE BOLTS WHEN NO JOIST IS AVAILABLE.

SECTION AT CLEAT

SECTIONAL ISOMETRIC VIEW SHOWING CLEAT LOCATIONS FOR CEILING MOUNTING



99 SOUTH STREET, PASSAIC, NJ 07055
(p) 973-916-1166 (e) estimating@rpgacoustic.com

Title: RPG MODFFRACTAL (4X2)
CLEAT CEILING MOUNTING

Proj: RPG PRODUCT

Date: 8/22/2022 By: CNN Scale: NTS

Path: F:\Project Mgmt - RPG\ - RPG PRODUCTS ALL PRODUCTS DRAWING\MODR_Modffractal\1- AutoCAD Drawings\Mounting

Comments:

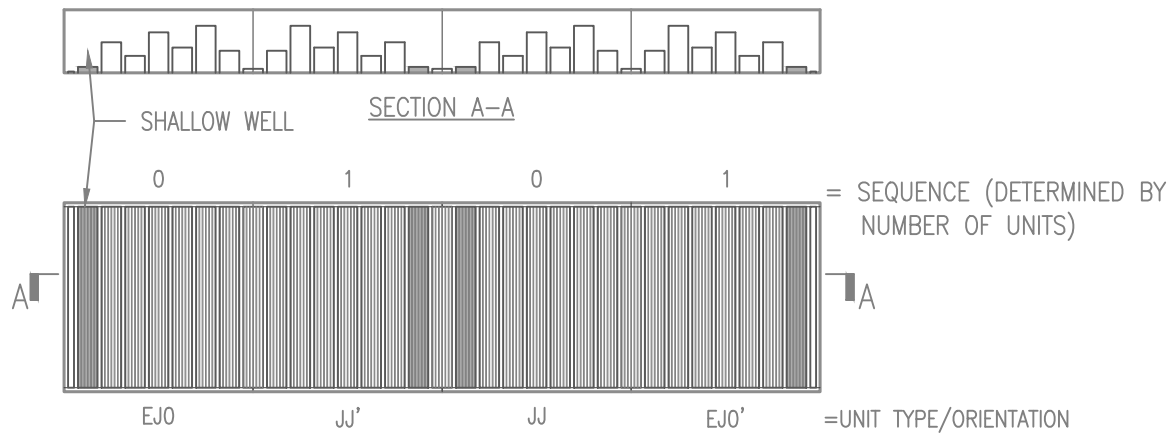
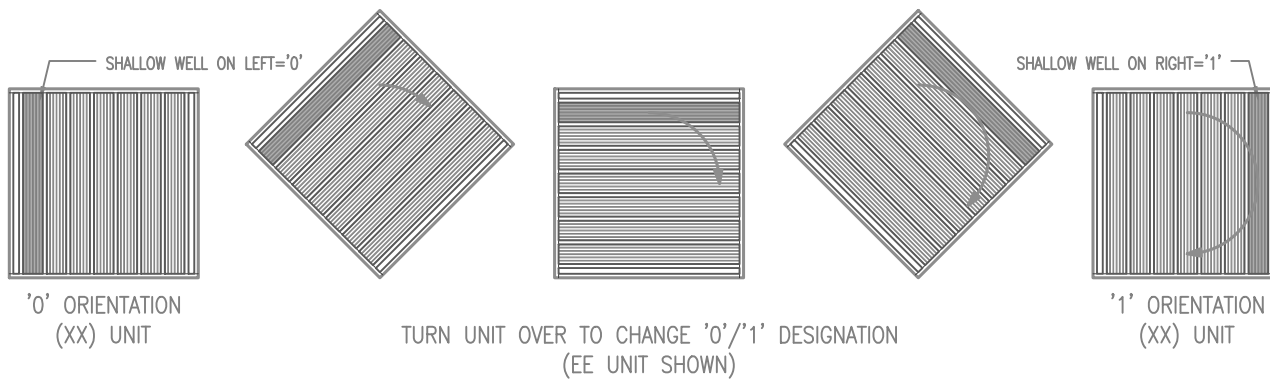

EJO
 LEFT SIDE END UNIT
 SHALLOW WELL ON LEFT
 JOINING ON RIGHT

JJ' (JJ ROTATED 180°)
 JOINING ON LEFT
 SHALLOW WELL NOW ON RIGHT
 JOINING ON RIGHT

JJ
 JOINING ON LEFT
 SHALLOW WELL ON LEFT
 JOINING ON RIGHT

EJO' (EJO ROTATED 180°)
 LEFT SIDE END UNIT NOW RIGHT SIDE END UNIT
 SHALLOW WELL ON LEFT NOW ON RIGHT
 JOINING ON RIGHT NOW ON LEFT

EXAMPLE

SEQUENCE NUMBERING
 0=SHALLOW WELL ON LEFT SIDE
 1=SHALLOW WELL ON RIGHT SIDE

UNIT TYPE DESIGNATION
 E=END
 J=JOINING
 '=ROTATED UNIT



99 SOUTH STREET, PASSAIC, NJ 07055
 (p) 973-916-1166 (e) estimating@rpgacoustic.com

Title: RPG MODFFRACTAL
SQUENCING DETAIL

Proj: RPG PRODUCT

Date: 8/22/22 By: _____ Scale: 1/2"=1'-0"

Comments:

Path: F:\Project Maint - RPG__RPG PRODUCTS\ALL PRODUCTS DRAWING\MODR_Modffractal\1- AutoCAD Drawings\Mounting

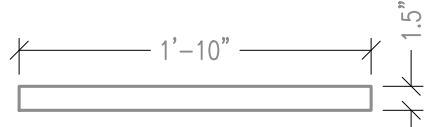
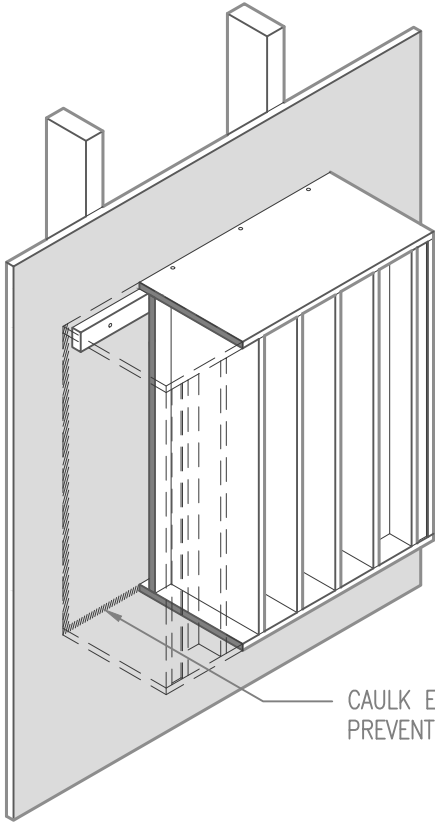

(1) 3/4" PLYWOOD CLEAT WILL BE PROVIDED FOR EACH UNIT

CAULK EDGES TO PREVENT VIBRATION

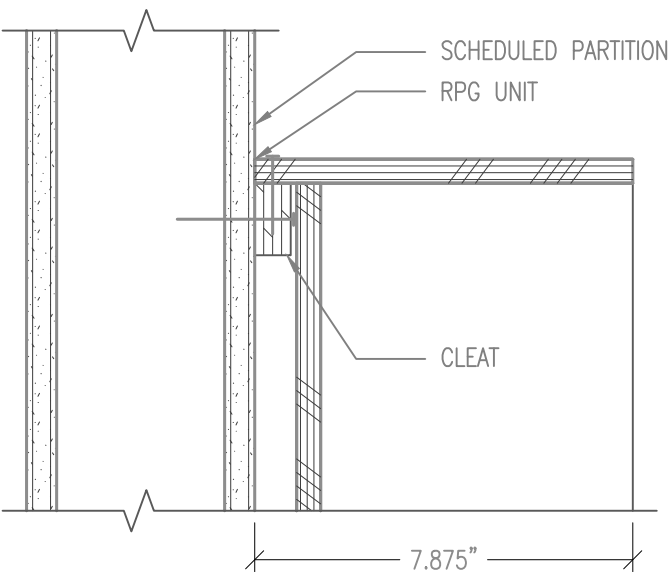

99 SOUTH STREET, PASSAIC, NJ 07055
 (p) 973-916-1166 (e) estimating@rpgacoustic.com

Title: RPG MODFFRACTAL (2X2)
 CLEAT MOUNTING

Proj: RPG PRODUCT

Date: 8/22/2022

By: CNN

Scale: NTS

Path: F:\Project Mgmt - RPG\ - RPG PRODUCTS\ALL PRODUCTS DRAWING\MODR_Modfractal\1- AutoCAD Drawings\Mounting

Comments:

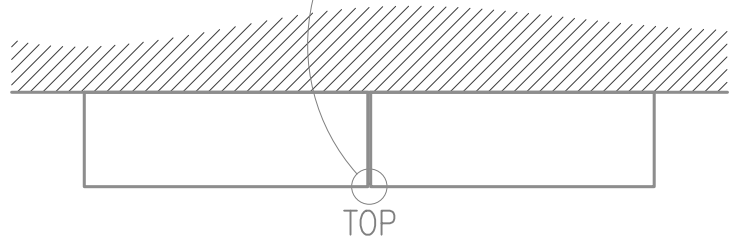
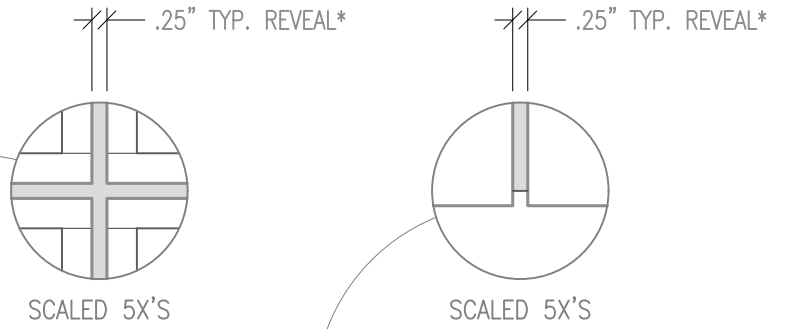
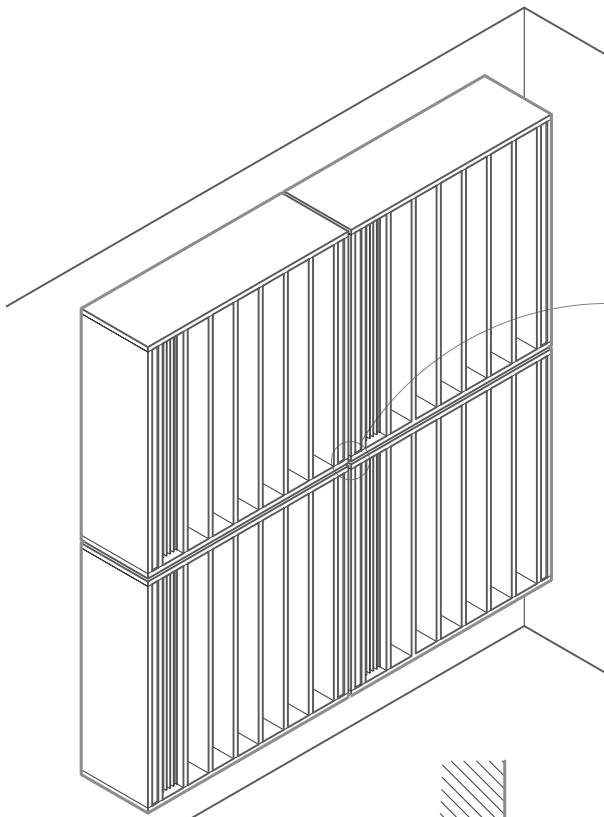

2x2 MODFFRACTAL

DRYWALL;
TO CONTRACTORS;
WALL SHALL ADJUST
TO SUPPORT WEIGHT
OF UNITS.

.25" TYP. REVEAL*

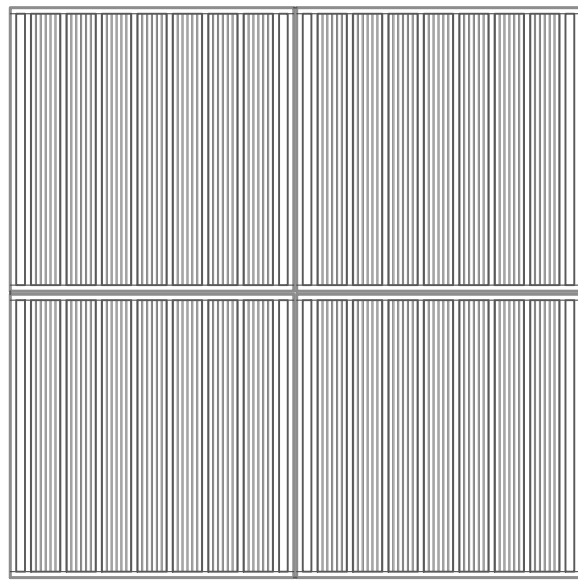
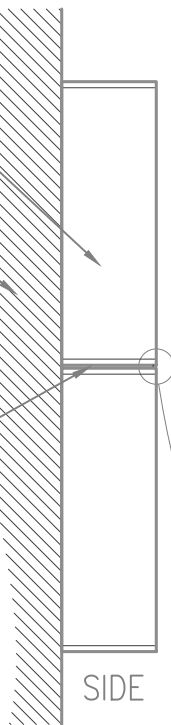

FRONT

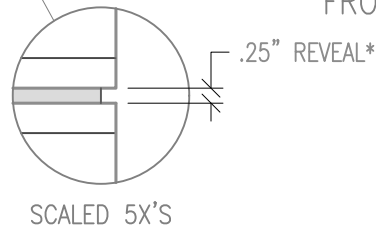

* SPACER WITHIN
REVEAL IS PROVIDED
BY OTHERS.



99 SOUTH STREET, PASSAIC, NJ 07055
(p) 973-916-1166 (e) estimating@rpgacoustic.com

Title: RPG MODFFRACTAL (2X2)
EE ARRAY

Proj: RPG PRODUCT

Date: 8/22/2022

By: CNN

Scale: 3/4" = 1'-0"

Comments:

Path: F:\Project Mgmt - RPG\ - RPG PRODUCTS\ALL PRODUCTS DRAWING\MODR_Modfractal\1 - AutoCAD Drawings\Mounting

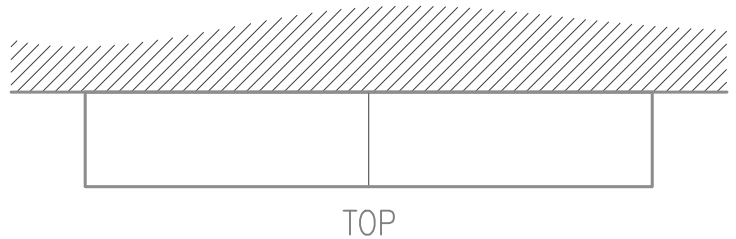
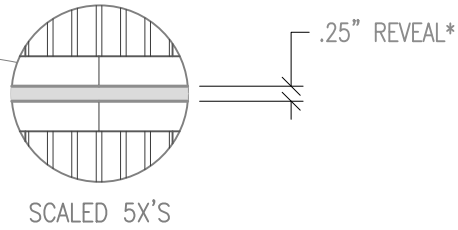
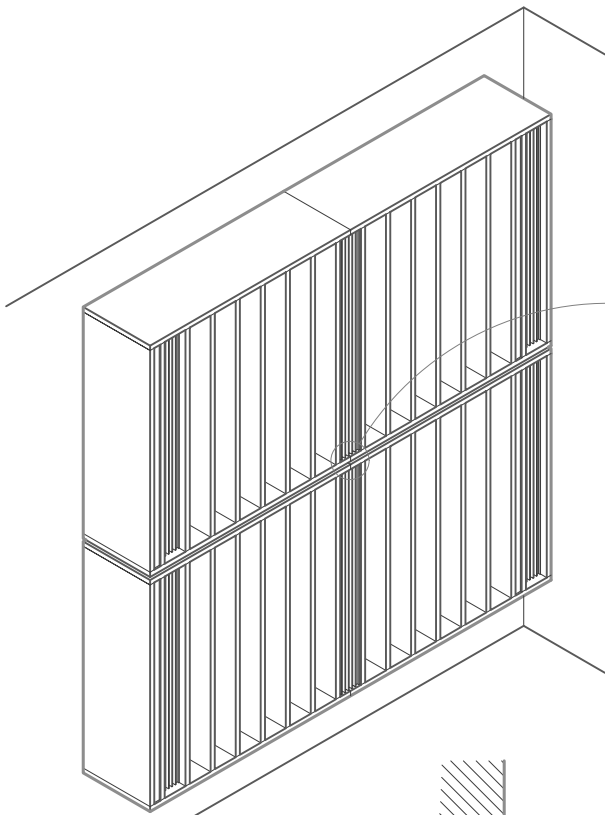

2x2 MODFFRACTAL

DRYWALL;
TO CONTRACTORS;
WALL SHALL ADJUST
TO SUPPORT WEIGHT
OF UNITS.

.25" TYP. REVEAL*

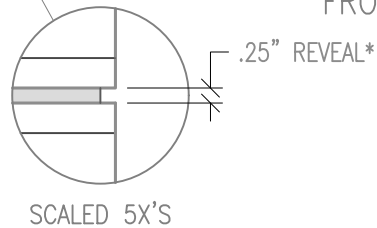
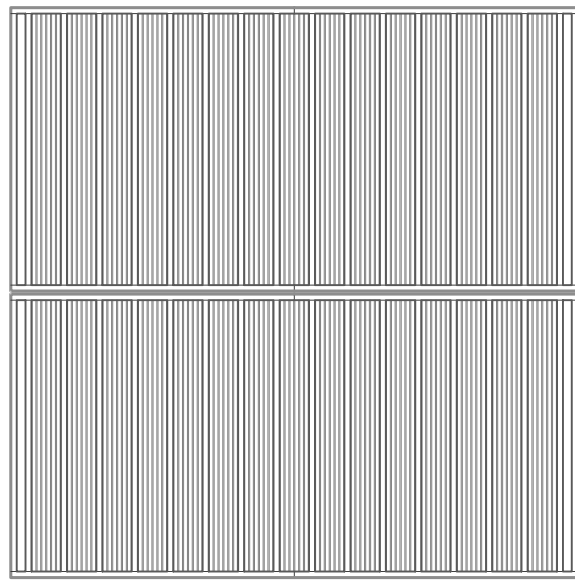
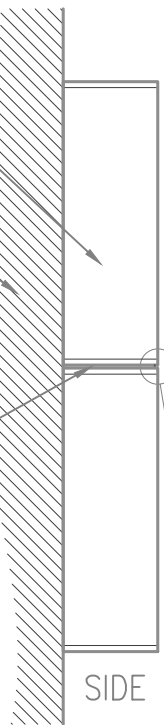

* SPACER WITHIN
REVEAL IS PROVIDED
BY OTHERS.



99 SOUTH STREET, PASSAIC, NJ 07055
(p) 973-916-1166 (e) estimating@rpgacoustic.com

Title: RPG MODFFRACTAL (2X2)
EJ ARRAY

Proj: RPG PRODUCT

Date: 8/22/2022

By:

Scale: 1"=1'-0"

Comments:

Path: F:\Project Mgmt - RPG\ - RPG PRODUCTS\ALL PRODUCTS DRAWING\MODR_Modffractal\1- AutoCAD Drawings\Mounting