

99 SOUTH STREET, PASSAIC, NJ 07055
(p) 973-916-1166 (e) estimating@rpgacoustic.com

Title: **RPG MODFFUSOR (2X2)**
JOINING WELL

Proj: **RPG PRODUCT**

Date: **8/24/22** By: **CNN** Scale: **3/4"=1'-0"**

Path: **F:\Project Maint - RPG\RPG PRODUCTS\ALL PRODUCTS DRAWING\MODF_Modffusor\1-AutoCAD Drawings\Mounting_Modffusor Mounting - R1**

Comments:

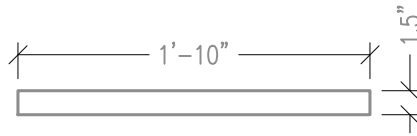
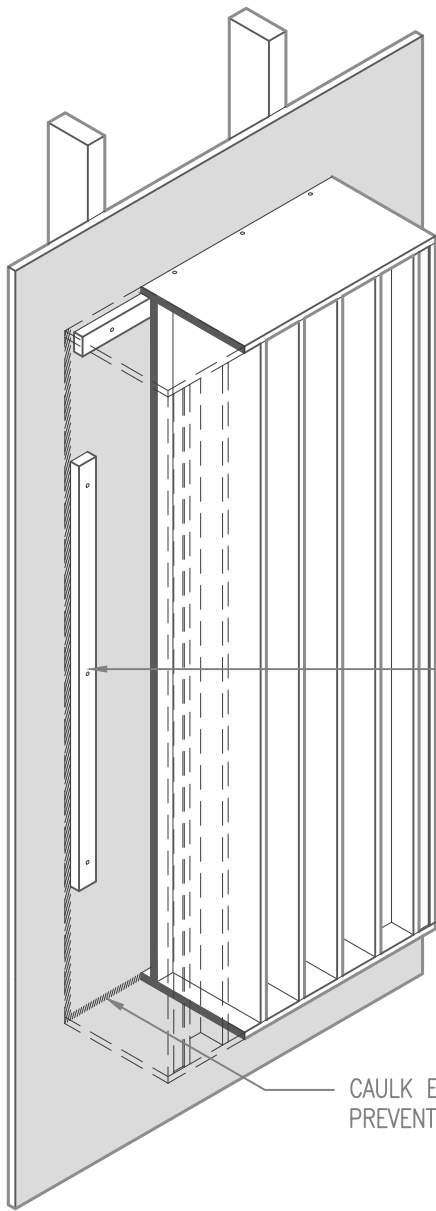

(1) 3/4" PLYWOOD CLEAT WILL BE PROVIDED FOR EACH UNIT

ADDITIONAL CLEATS MAY BE REQUIRED FOR UNITS OVER 48" TALL

CAULK EDGES TO PREVENT VIBRATION

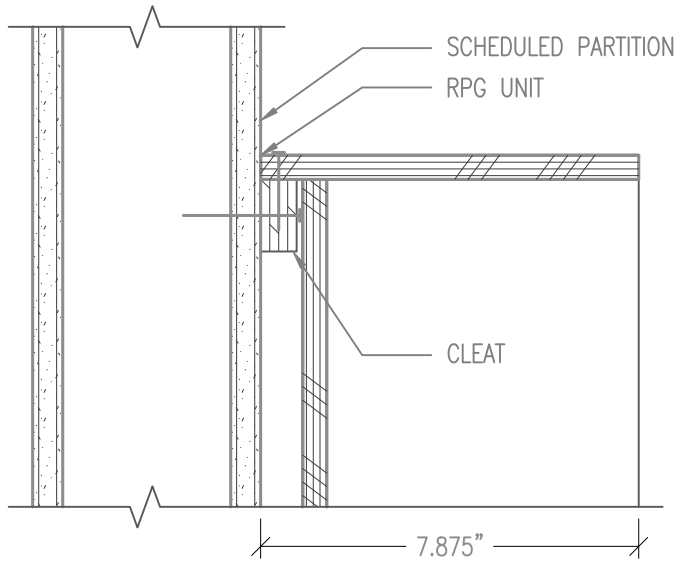

99 SOUTH STREET, PASSAIC, NJ 07055
 (p) 973-916-1166 (e) estimating@rpgacoustic.com

Title: RPG MODDIFFUSOR (4X2)
 CLEAT MOUNTING

Proj: RPG PRODUCT

Date: 8/24/22

By: CNN

Scale: NTS

Comments:

Path: F:\Project Maint - RPG\RPG PRODUCTS\ALL PRODUCTS DRAWING\MODIFFUSOR\I-AutoCAD Drawings\Mounting\Moddiffusor Mounting - R1

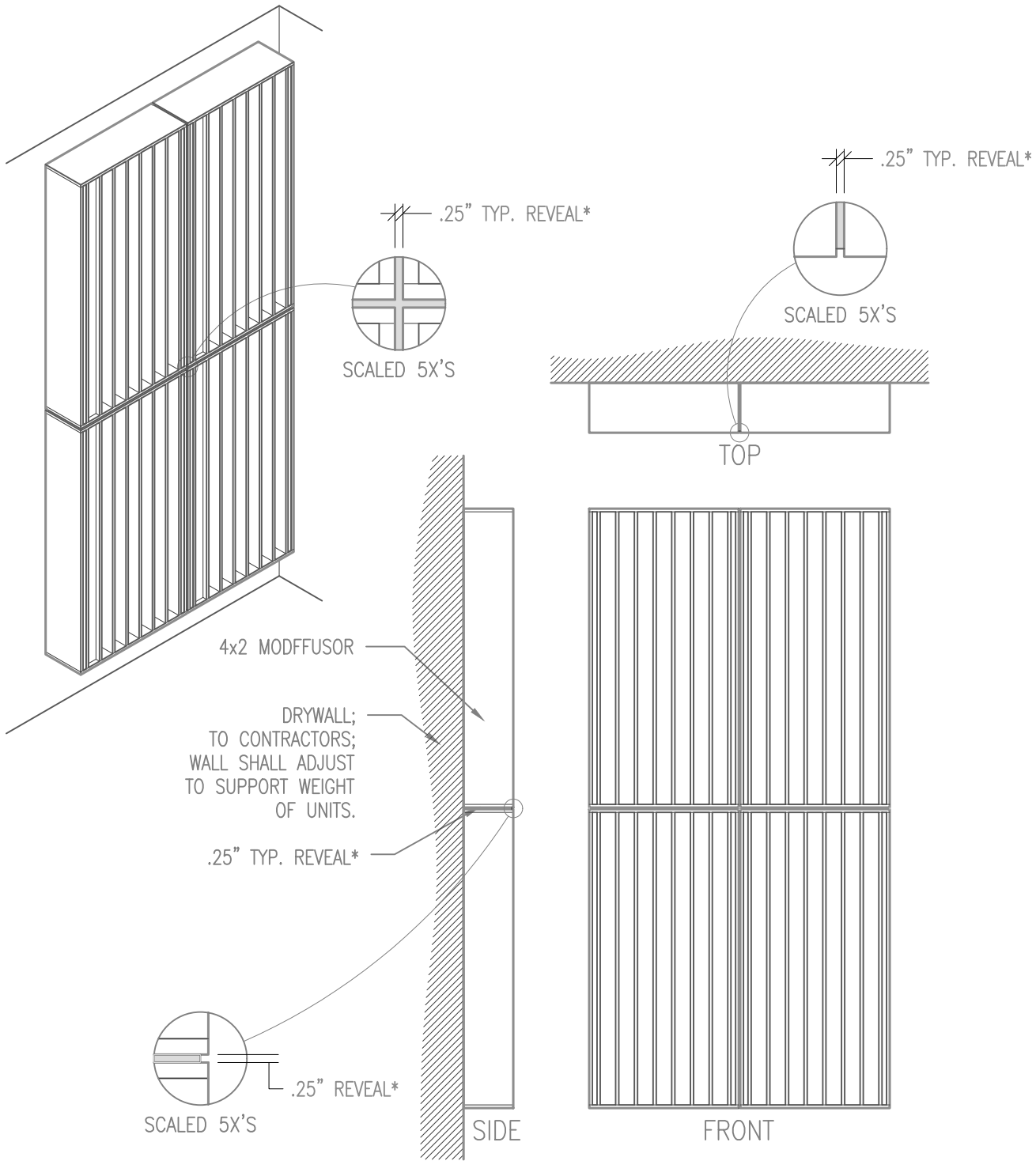

* SPACER WITHIN REVEAL IS PROVIDED BY OTHERS.



99 SOUTH STREET, PASSAIC, NJ 07055
(p) 973-916-1166 (e) estimating@rpgacoustic.com

Title: RPG MODFFUSOR (4X2)
EE ARRAY

Proj: RPG PRODUCT

Date: 8/24/22

By: CNN

Scale: 1/2" = 1'-0"

Comments:

Path: F:\Project Maint - RPG\PROJECTS\ALL PRODUCTS DRAWING\MODF_Modfusor\1-AutoCAD Drawings\Mounting_Modfusor Mounting - R1

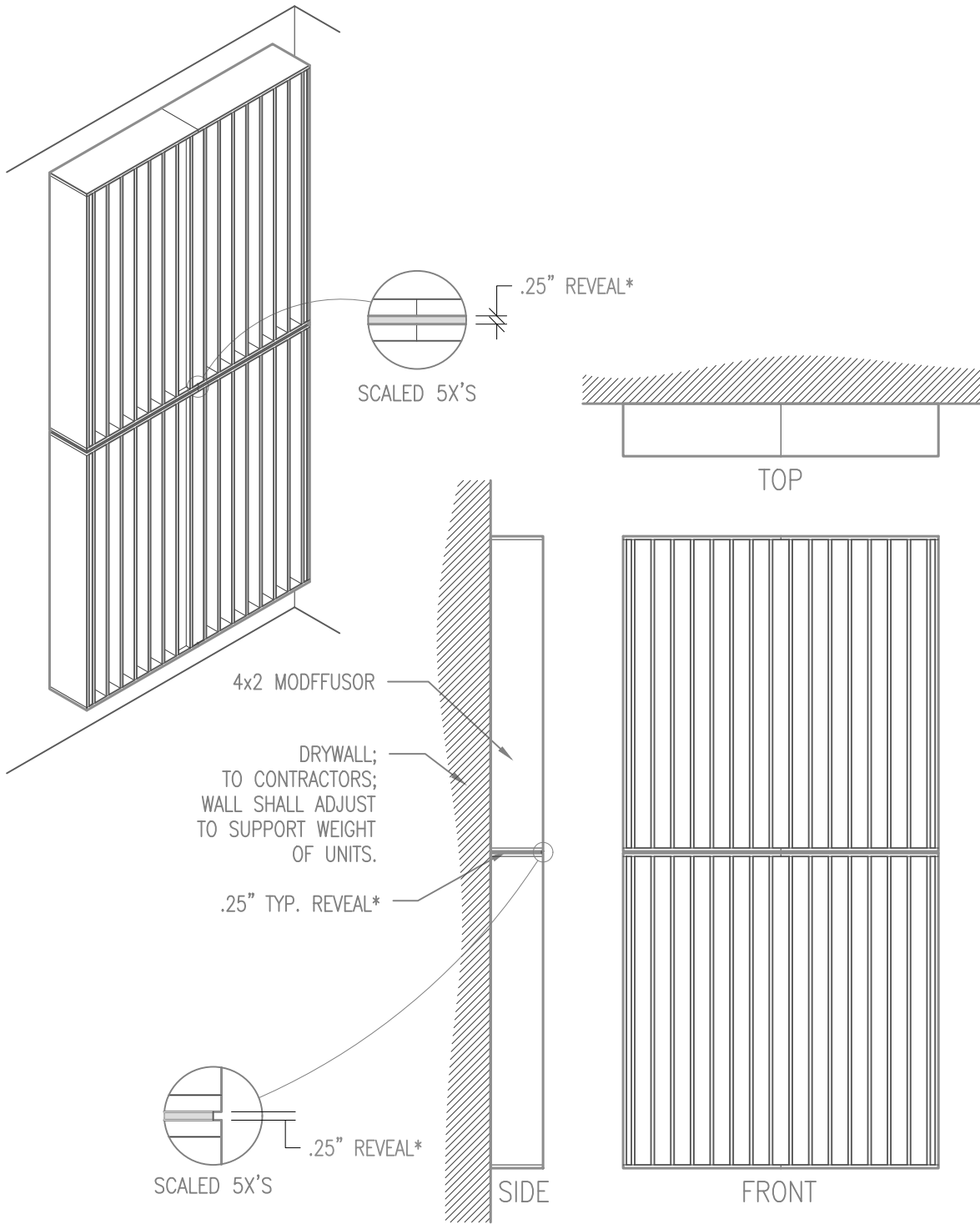

* SPACER WITHIN REVEAL IS PROVIDED BY OTHERS.



99 SOUTH STREET, PASSAIC, NJ 07055
 (p) 973-916-1166 (e) estimating@rpgacoustic.com

Title: **RPG MODFFUSOR (4X2)**
EJ ARRAY

Proj: **RPG PRODUCT**

Date: **8/24/22** By: **CNN** Scale: **1/2" = 1'-0"**

Comments:

Path: F:\Project Maint - RPG\RPG PRODUCTS\ALL PRODUCTS DRAWING\MODF_Modffusor\1-AutoCAD Drawings\Mounting_Modffusor Mounting - R1

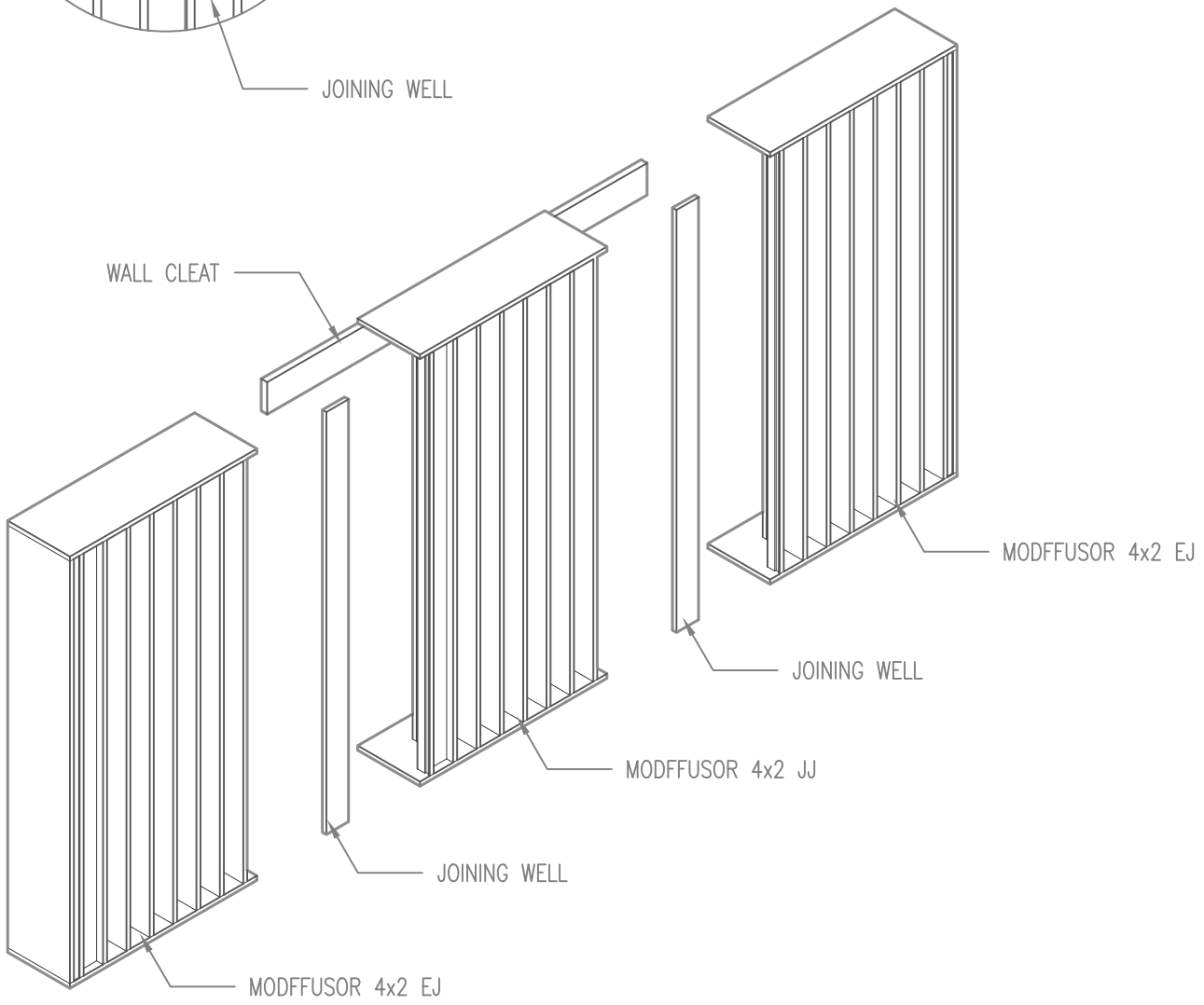
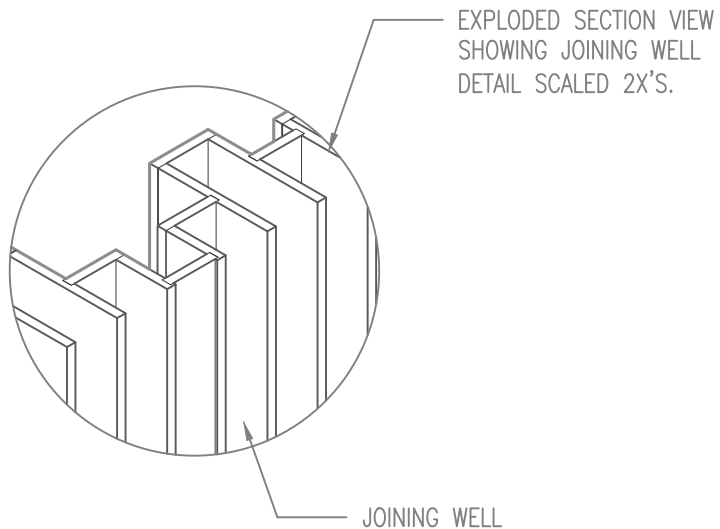

99 SOUTH STREET, PASSAIC, NJ 07055
(p) 973-916-1166 (e) estimating@rpgacoustic.com

Title: RPG MODFFUSOR (4X2)
JOINING WELL

Proj: RPG PRODUCT

Date: 8/24/22 By: CNN Scale: 3/4" = 1'-0"

Path: F:\Project Maint - RPG\RPG PRODUCTS\ALL PRODUCTS DRAWING\MODF_Modffusor\1-AutoCAD Drawings\Mounting_Modffusor Mounting - R1

Comments:

ATTACH UNITS TO CEILING MOUNTED CLEATS USING TRIM HEAD SCREWS TO MINIMIZE PENETRATIONS IN THE SIDES OF THE UNITS. USE WOOD PUTTY TO FILL HOLES.

CAULK EDGES TO PREVENT VIBRATIONS

ADDITIONAL CLEATS MAY BE REQUIRED FOR UNITS OVER 48" TALL.

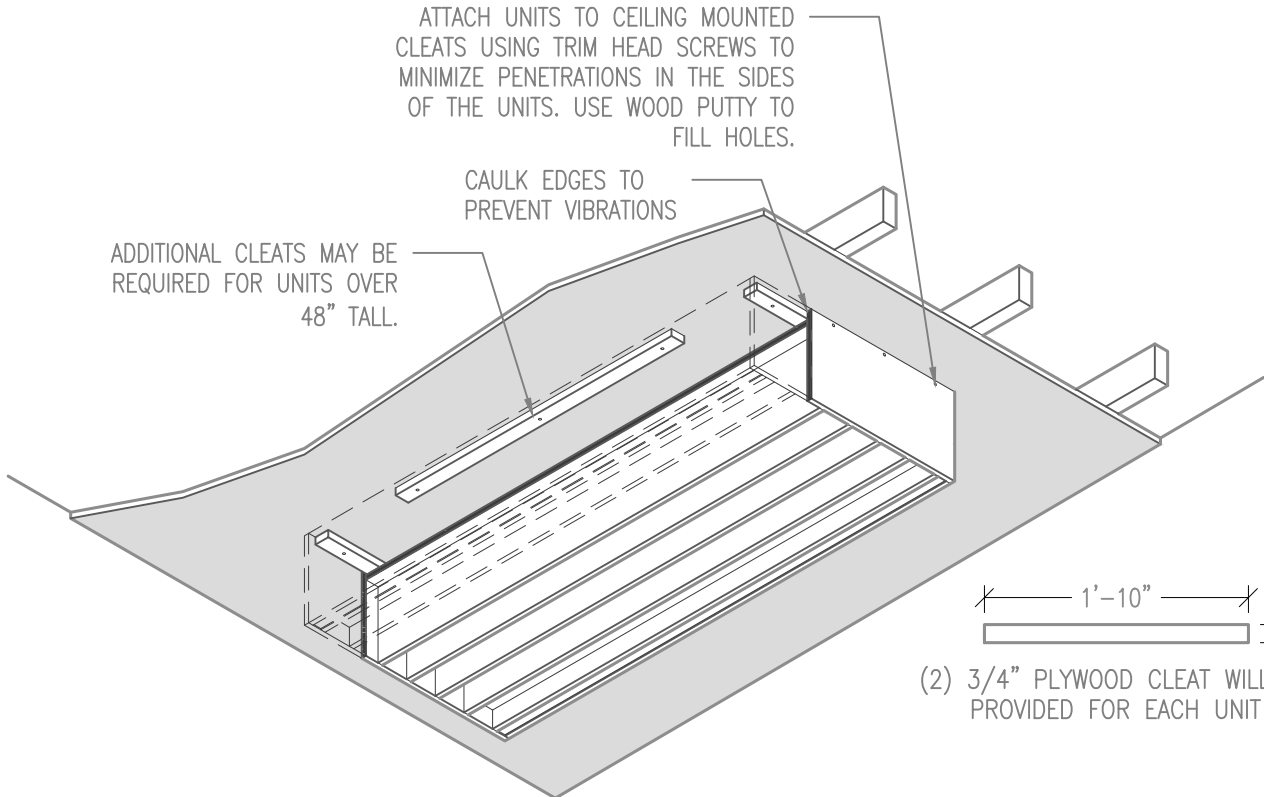

(2) 3/4" PLYWOOD CLEAT WILL BE PROVIDED FOR EACH UNIT

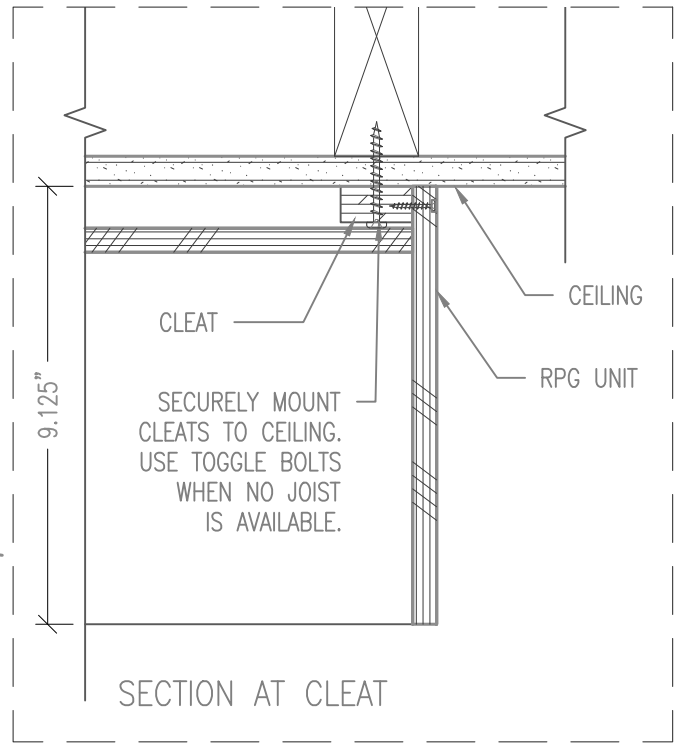

SECTIONAL ISOMETRIC VIEW SHOWING CLEAT LOCATIONS FOR CEILING MOUNTING



99 SOUTH STREET, PASSAIC, NJ 07055
(p) 973-916-1166 (e) estimating@rpgacoustic.com

Title: RPG MODFFUSOR 2X2 EE CUTSHEET

Proj: RPG PRODUCT

Date: 8/24/22

By: CNN

Scale: NTS

Comments:

Four horizontal lines for entering comments.

Path: F:\Project Mgmt - RPG\PROJECTS\ALL PRODUCTS DRAWING\MODF_Modffusor\1-AutoCAD Drawings\Mounting\Modffusor Mounting - RI

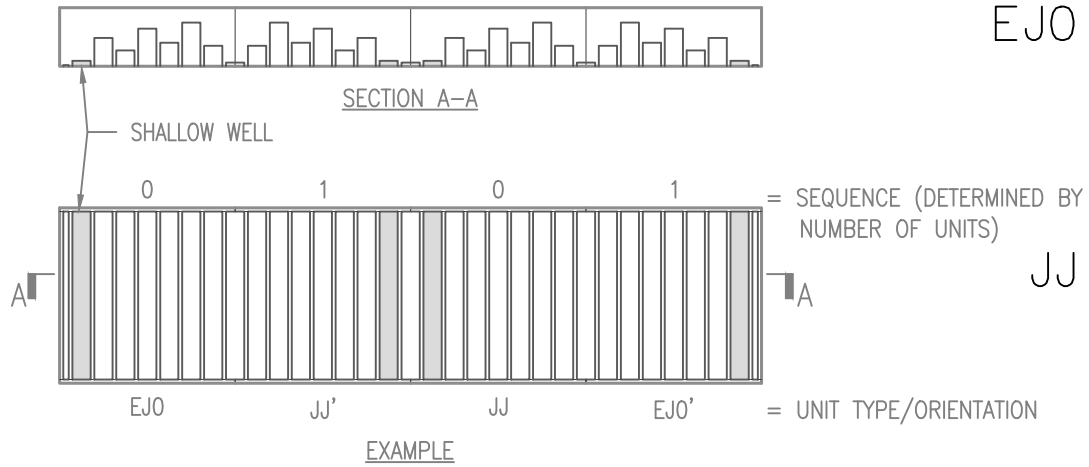
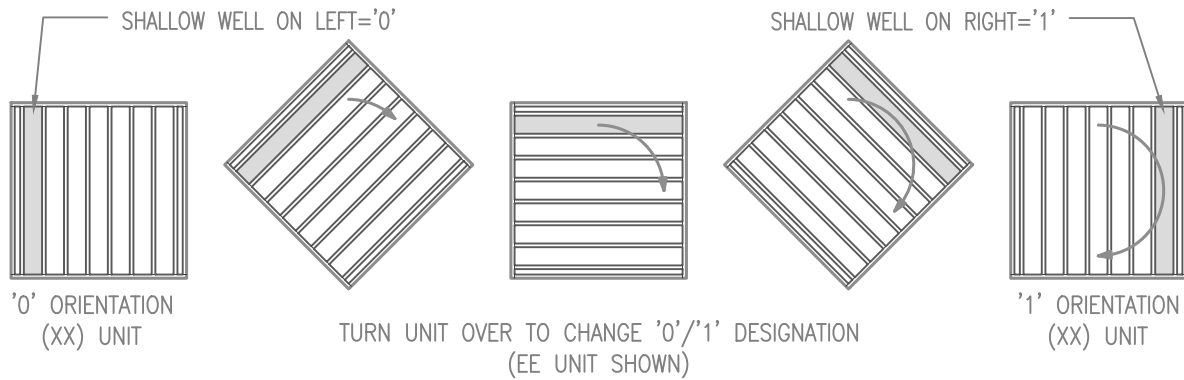

EJO
 LEFT SIDE END UNIT
 SHALLOW WELL ON LEFT
 JOINING ON RIGHT

JJ' (JJ ROTATED 180°)
 JOINING ON LEFT
 SHALLOW WELL NOW ON RIGHT
 JOINING ON RIGHT

JJ
 JOINING ON LEFT
 SHALLOW WELL ON LEFT
 JOINING ON RIGHT

EJO' (EJO ROTATED 180°)
 LEFT SIDE END UNIT NOW RIGHT SIDE END UNIT
 SHALLOW WELL ON LEFT NOW ON RIGHT
 JOINING ON RIGHT NOW ON LEFT

SEQUENCE NUMBERING
 0=SHALLOW WELL ON LEFT SIDE
 1=SHALLOW WELL ON RIGHT SIDE

UNIT TYPE DESIGNATION
 E=END
 J=JOINING
 '=ROTATED UNIT



99 SOUTH STREET, PASSAIC, NJ 07055
 (p) 973-916-1166 (e) estimating@rpgacoustic.com

Title: RPG MODFFUSOR SEQUENCING DETAIL

Proj: RPG PRODUCT

Date: 8/24/22 By: CNN Scale: 1/2" = 1'-0"

Path: F:\Project Mgmt - RPG\PROJECTS\ALL PRODUCTS DRAWING\MODF_Modffusor\1-AutoCAD Drawings\Mounting\Modffusor Mounting - R1

Comments:

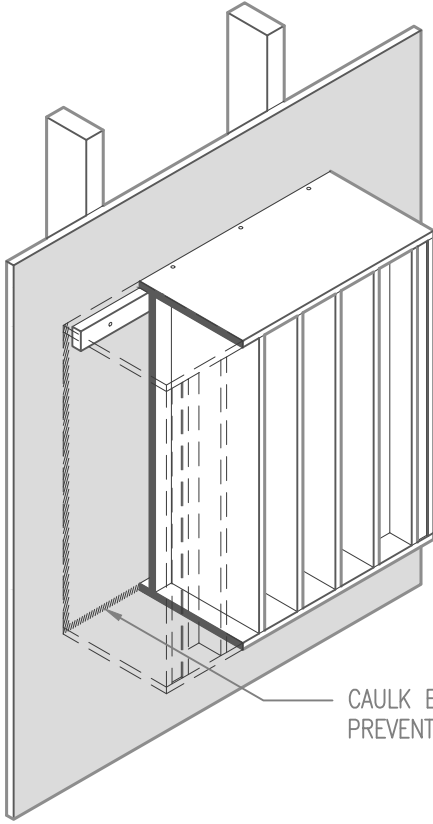

CAULK EDGES TO PREVENT VIBRATION

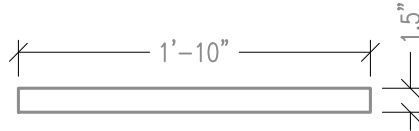

(1) 3/4" PLYWOOD CLEAT WILL BE PROVIDED FOR EACH UNIT

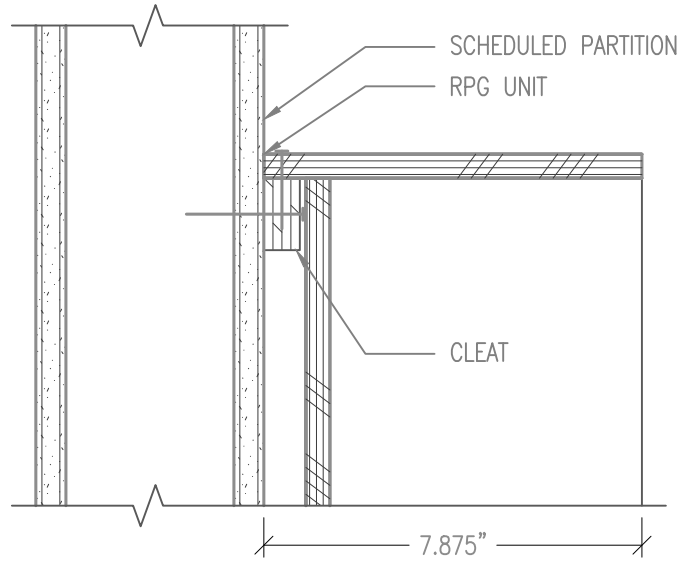

99 SOUTH STREET, PASSAIC, NJ 07055
 (p) 973-916-1166 (e) estimating@rpgacoustic.com

Title: RPG MODDIFFUSOR (2X2)
 CLEAT MOUNTING

Proj: RPG PRODUCT

Date: 8/24/22

By: CNN

Scale: NTS

Comments:

Path: F:\Project Maint - RPG\RPG PRODUCTS\ALL PRODUCTS DRAWING\MODIFFUSOR\1-AutoCAD Drawings\Mounting\Moddiffusor Mounting - R1

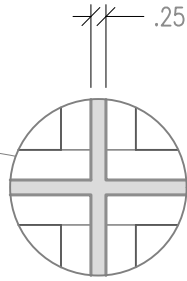
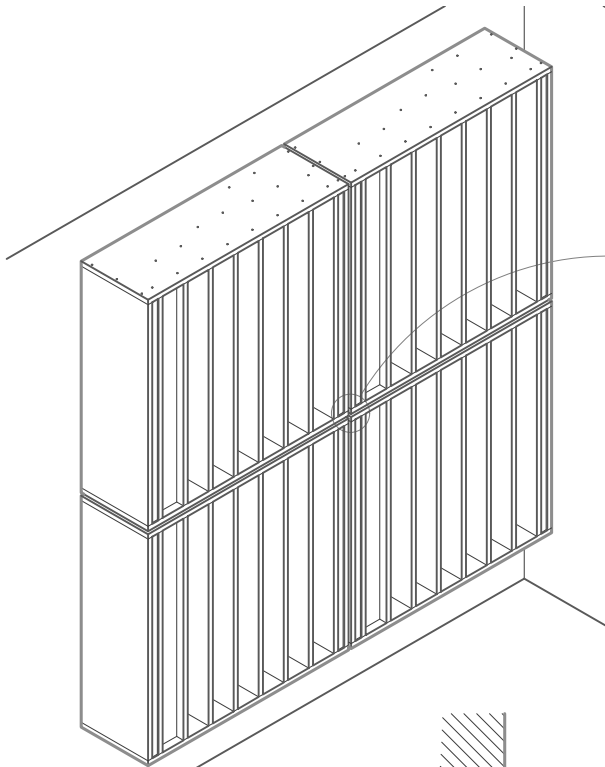

SCALED 5X'S

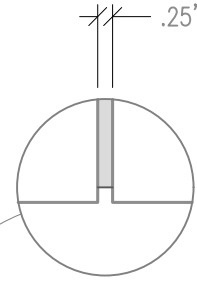

SCALED 5X'S

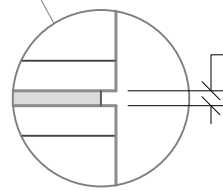
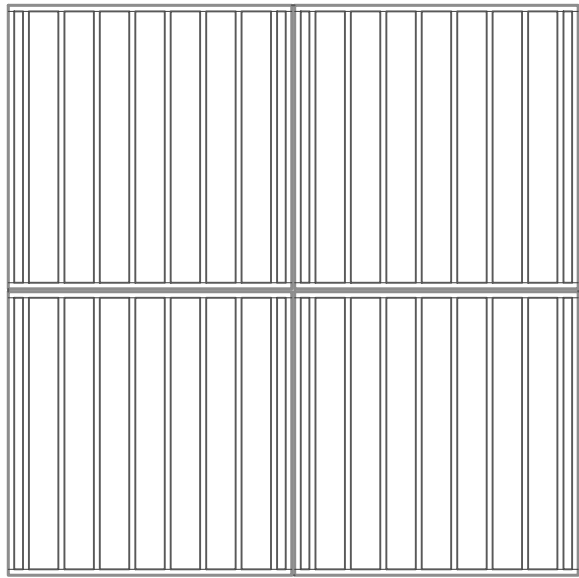
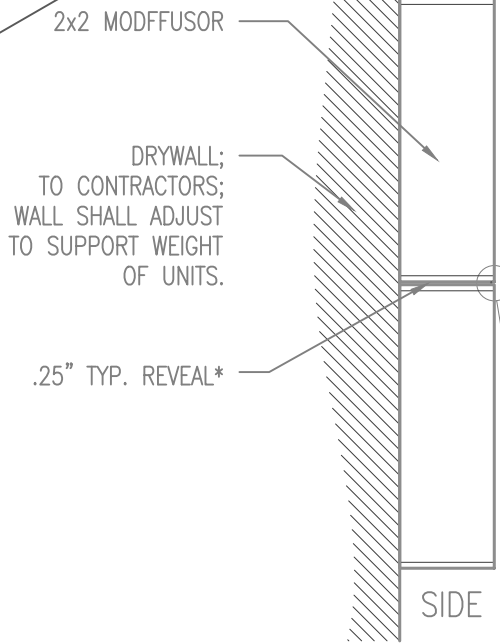
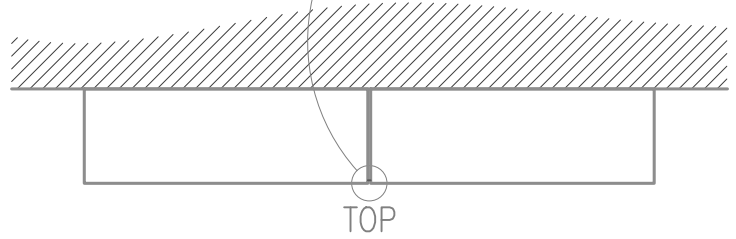

SCALED 5X'S

* SPACER WITHIN REVEAL IS PROVIDED BY OTHERS.



99 SOUTH STREET, PASSAIC, NJ 07055
(p) 973-916-1166 (e) estimating@rpgacoustic.com

Title: RPG MODFFUSOR (2X2)
EE ARRAY

Proj: RPG PRODUCT

Date: 8/24/22

By: CNN

Scale: 3/4" = 1'-0"

Comments:

Path: F:\Project Mgmt - RPG\RPG PRODUCTS\ALL PRODUCTS DRAWING\MODF_Modffusor\1-AutoCAD Drawings\Mounting\Modffusor Mounting - R1

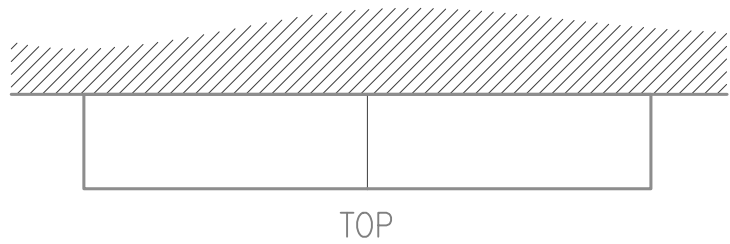
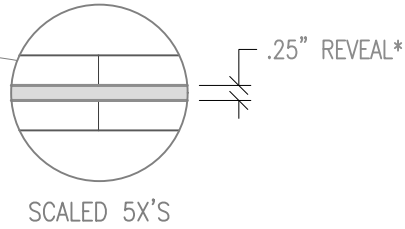
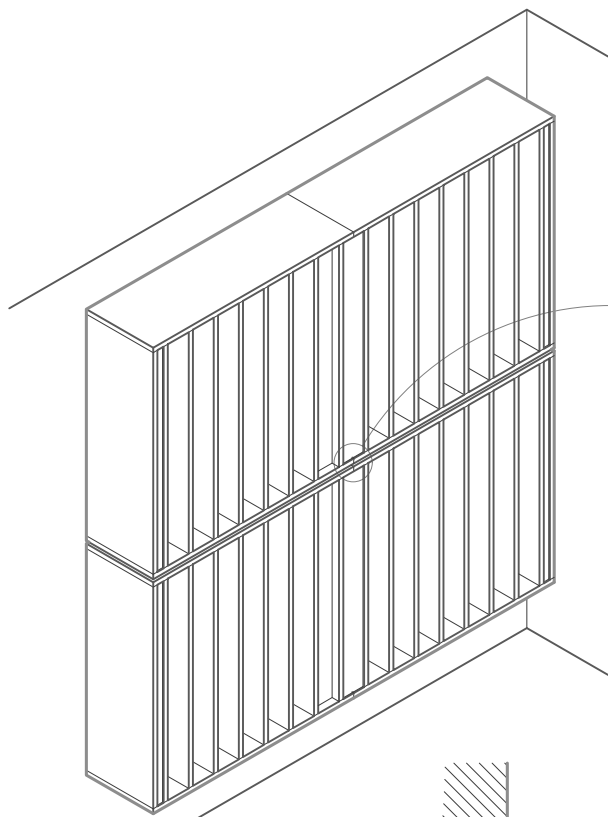

2x2 MODFFUSOR

DRYWALL;
TO CONTRACTORS;
WALL SHALL ADJUST
TO SUPPORT WEIGHT
OF UNITS.

.25" TYP. REVEAL*

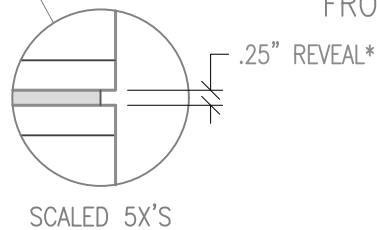
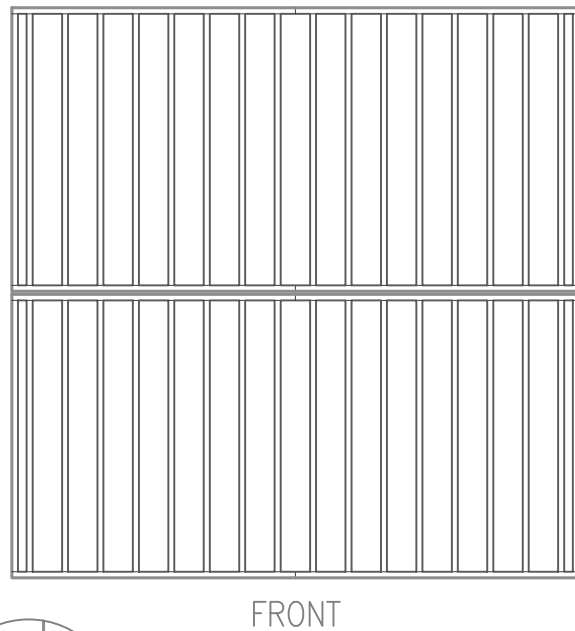
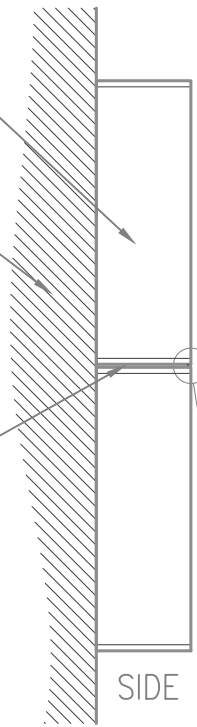

* SPACER WITHIN
REVEAL IS PROVIDED
BY OTHERS.



99 SOUTH STREET, PASSAIC, NJ 07055
(p) 973-916-1166 (e) estimating@rpgacoustic.com

Title: RPG MODFFUSOR (2X2)
EJ ARRAY

Proj: RPG PRODUCT

Date: 8/24/22 By: CNN Scale: 3/4" = 1'-0"

Path: F:\Project Maint - RPG\PROJECTS\ALL PRODUCTS DRAWING\MODFFUSOR\1-AutoCAD Drawings\Mounting\Modffusor Mounting - R1

Comments:
