

QTY./LENGTH				
	24"	48"	72"	96"
24"	4	4	6	8
48"	4	4	6	8
72"	6	6	-	-
96"	8	8	-	-

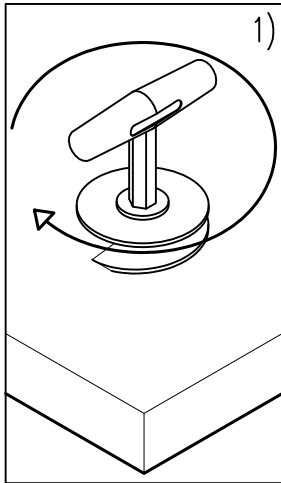

99 SOUTH STREET, PASSAIC, NJ 07055
(P) 973-916-1166 (E) estimating@rpgacoustic.com

Title: RPG MODSORBOR PANEL MOUNTING #3 ROTOFAST™ EYELET			Label:	
Proj: RPG MOUNTING		JOB#:		Line Item:
Date: 8/25/22 WRM		By: I"=1'-0"		
Path: F:\Project Mgmt - RPG__RPG PRODUCTS\ALL PRODUCTS DRAWING\MDSP_Modsorbor Panel\1- AutoCAD Drawings\Mounting\Modsorbor Mounting RI			QTY.	
Scale:				



1)

ATTACH ROTOFAST™ ANCHOR

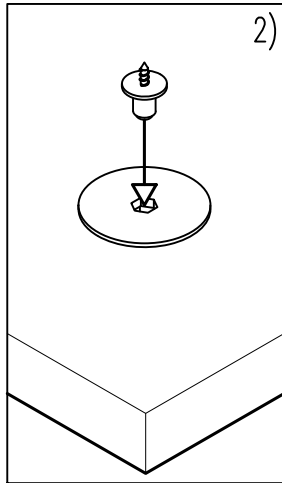

2)

INSERT MARKER SCREW

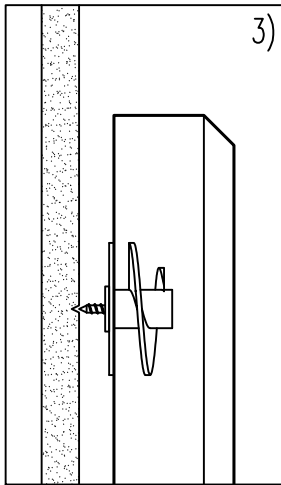

3)

MARK WALL

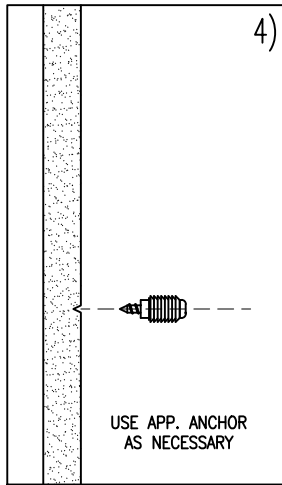

4)

USE APP. ANCHOR
AS NECESSARY

MOUNT STUDS

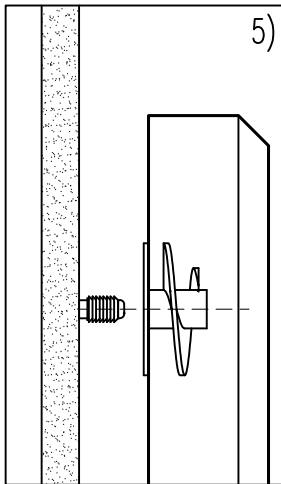

5)

REMOVE MARKER SCREW

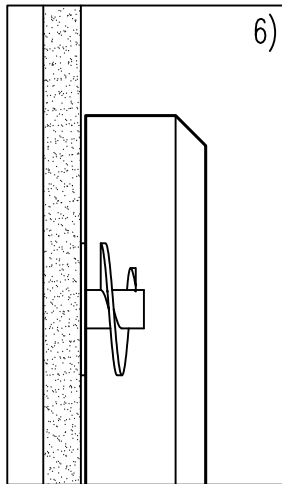

6)

SNAP PANEL ONTO STUDS

QTY./LENGTH		24"	48"	72"	96"
24"	4	4	6	8	
48"	4	4	6	8	
72"	6	6	-	-	
96"	8	8	-	-	

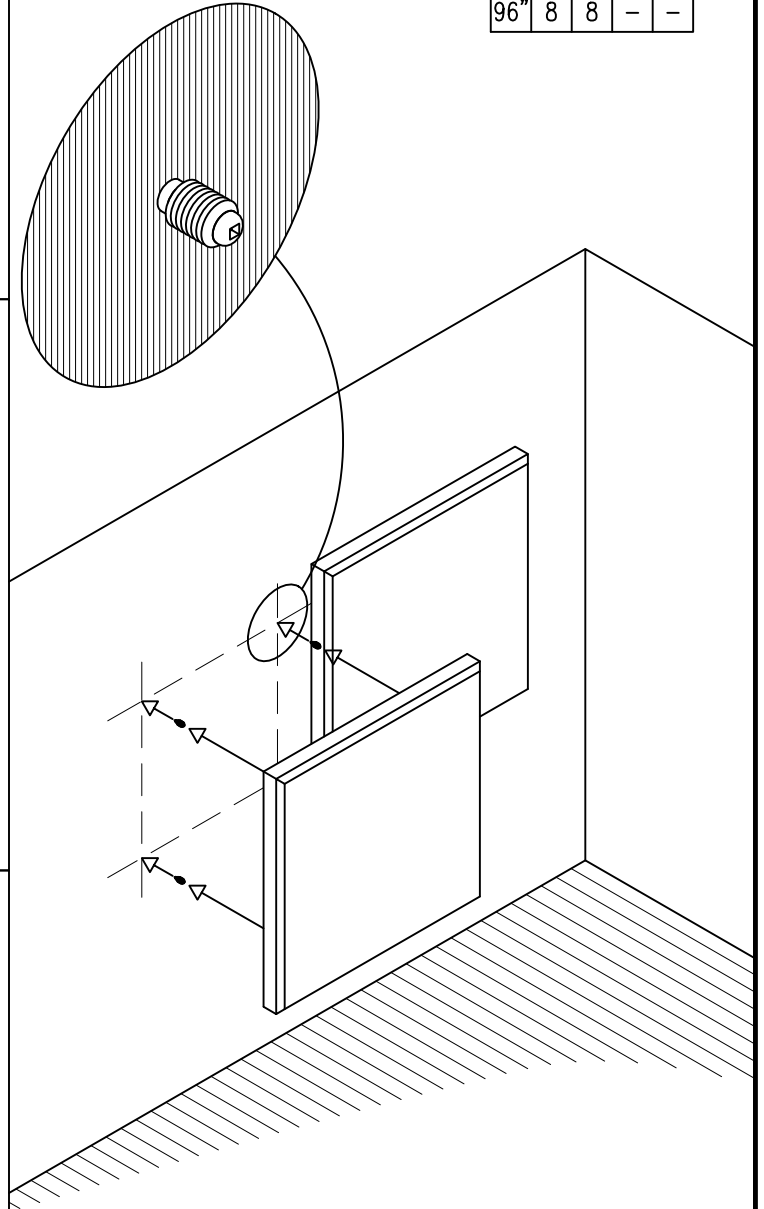

99 SOUTH STREET, PASSAIC, NJ 07055
(P) 973-916-1166 (E) estimating@rpgacoustic.com

Title: RPG MODSORBOR PANEL
MOUNTING #4 ROTOFAST™ SNAP-ON

Label:

Proj: RPG MOUNTING

JOB#:

Line Item:

QTY.

Date: 8/25/22

By:

3/4/

Scale:

Path: F:\Project Mgmt - RPG\RPG PRODUCTS\ALL PRODUCTS DRAWING\MDSP_Modsorbor Panel\1- AutoCAD Drawings\Mounting\Modsorbor Mounting.R1

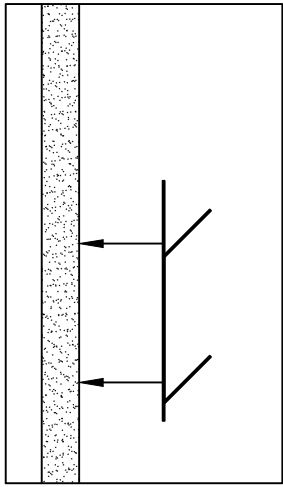

ATTACH IMPALING CLIPS TO WALL.

QTY./LENGTH	QTY./LENGTH			
	24"	48"	72"	96"
24"	4	4	6	8
48"	4	4	6	8
72"	6	6	-	-
96"	8	8	-	-

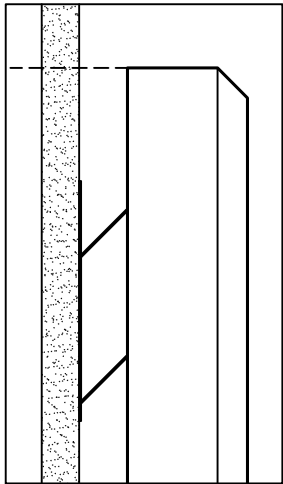

DRAW A LINE 1" ABOVE DESIRED HEIGHT.

GENTLY REST PANEL AGAINST CLIPS MAINTAINING LEVEL WITH LINE.

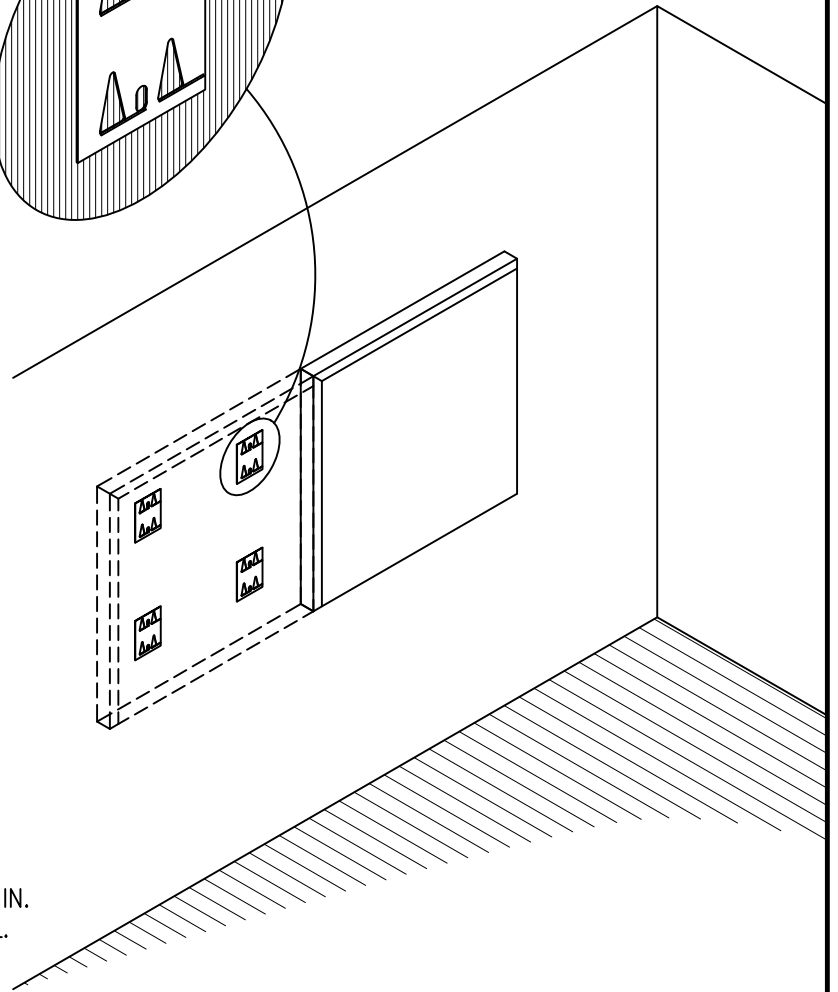
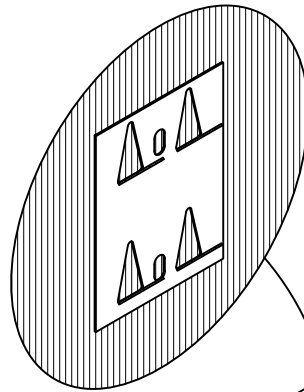

PUSH FIRMLY DOWN & IN. PIERCE BACK OF PANEL.

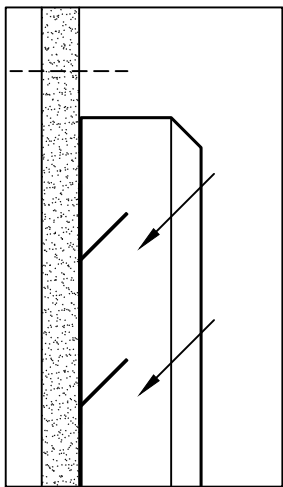

99 SOUTH STREET, PASSAIC, NJ 07055
(P) 973-916-1166 (E) estimating@rpgacoustic.com

Title: RPG MODSORBOR PANEL MOUNTING #1 IMPALING CLIPS

Label:

Proj: RPG MOUNTING

JOB#:

Line Item: QTY.

Date: 8/25/22

By:

Scale: 3/4" = 1'-0"

Path: F:\Project Mgmt - RPG\ - RPG PRODUCTS\ALL PRODUCTS DRAWING\MDSP_Modsorbor Panel\ - AutoCAD Drawings\Mounting\Modsorbor Mounting.R1

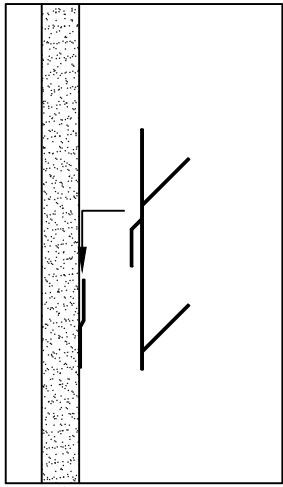

ATTACH Z-CLIPS
TO WALL, HANG
IMPALING CLIPS

QTY./LENGTH				
	24"	48"	72"	96"
24"	4	4	6	8
48"	4	4	6	8
72"	6	6	-	-
96"	8	8	-	-

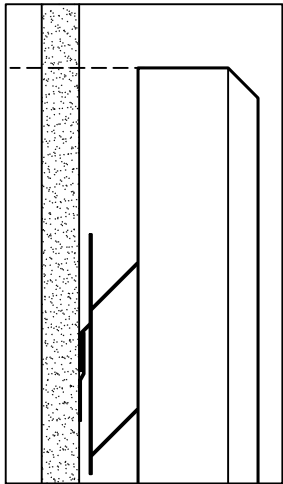

DRAW A LINE 1"
ABOVE DESIRED
HEIGHT.

GENTLY REST
PANEL AGAINST
CLIPS MAINTAINING
LEVEL WITH LINE.

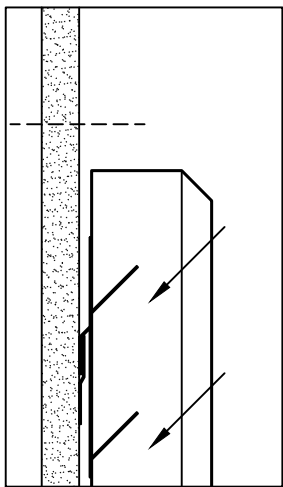

PUSH FIRMLY DOWN & IN.
PIERCE BACK OF PANEL.

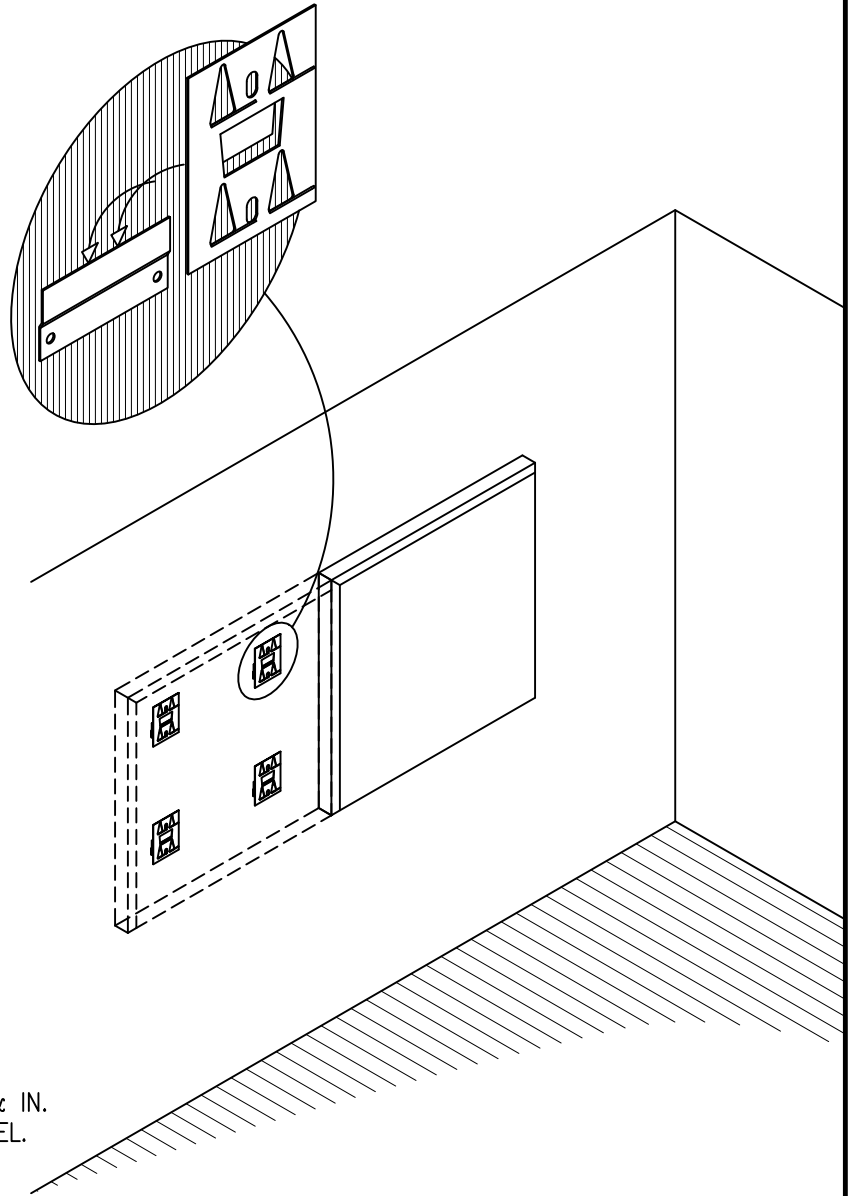

99 SOUTH STREET, PASSAIC, NJ 07055
(P) 973-916-1166 (E) estimating@rpgacoustic.com

Title: **RPG MODSORBOR PANEL
MOUNTING #2 IMPALING Z-CLIPS**

Label:

Proj: **RPG MOUNTING**

JOB#:

Line Item: QTY.

Date: **8/25/22**

By:

Scale: **3/4" = 1'-0"**

Path: **F:\Project Mgmt - RPG\RPG PRODUCTS\ALL PRODUCTS DRAWING\MDSP_Modsorbor Panel\1- AutoCAD Drawings\Mounting\Modsorbor Mounting.R1**